

Troop 1292 # 93A

MERIT BADGE SERIES



# RADIO



BOY SCOUTS OF AMERICA

STEM-Based

## HOW TO USE THIS PAMPHLET

The secret to successfully earning a merit badge is for you to use both the pamphlet and the suggestions of your counselor.

Your counselor can be as important to you as a coach is to an athlete. Use all of the resources your counselor can make available to you.

This may be the best chance you will have to learn about this particular subject. Make it count.

If you or your counselor feels that any information in this pamphlet is incorrect, please let us know. Please state your source of information.

Merit badge pamphlets are reprinted annually and requirements updated regularly. Your suggestions for improvement are welcome.

Send comments along with a brief statement about yourself to National Advancement Committee, S209 • Boy Scouts of America • 1325 West Walnut Hill Lane • P.O. Box 152079 • Irving, TX 75015-2079 • [merit.badge@Scouting.org](mailto:merit.badge@Scouting.org).

## WHO PAYS FOR THIS PAMPHLET?

This merit badge pamphlet is one in a series of more than 100 covering all kinds of hobby and career subjects. It is made available for you to buy as a service of the national and local councils, Boy Scouts of America. The costs of the development, writing, and editing of the

merit badge pamphlets are paid for by the Boy Scouts of America in order to bring you the best book at a reasonable price.

BOY SCOUTS OF AMERICA  
MERIT BADGE SERIES

# RADIO



*"Enhancing our youths' competitive edge through merit badges"*



BOY SCOUTS OF AMERICA®

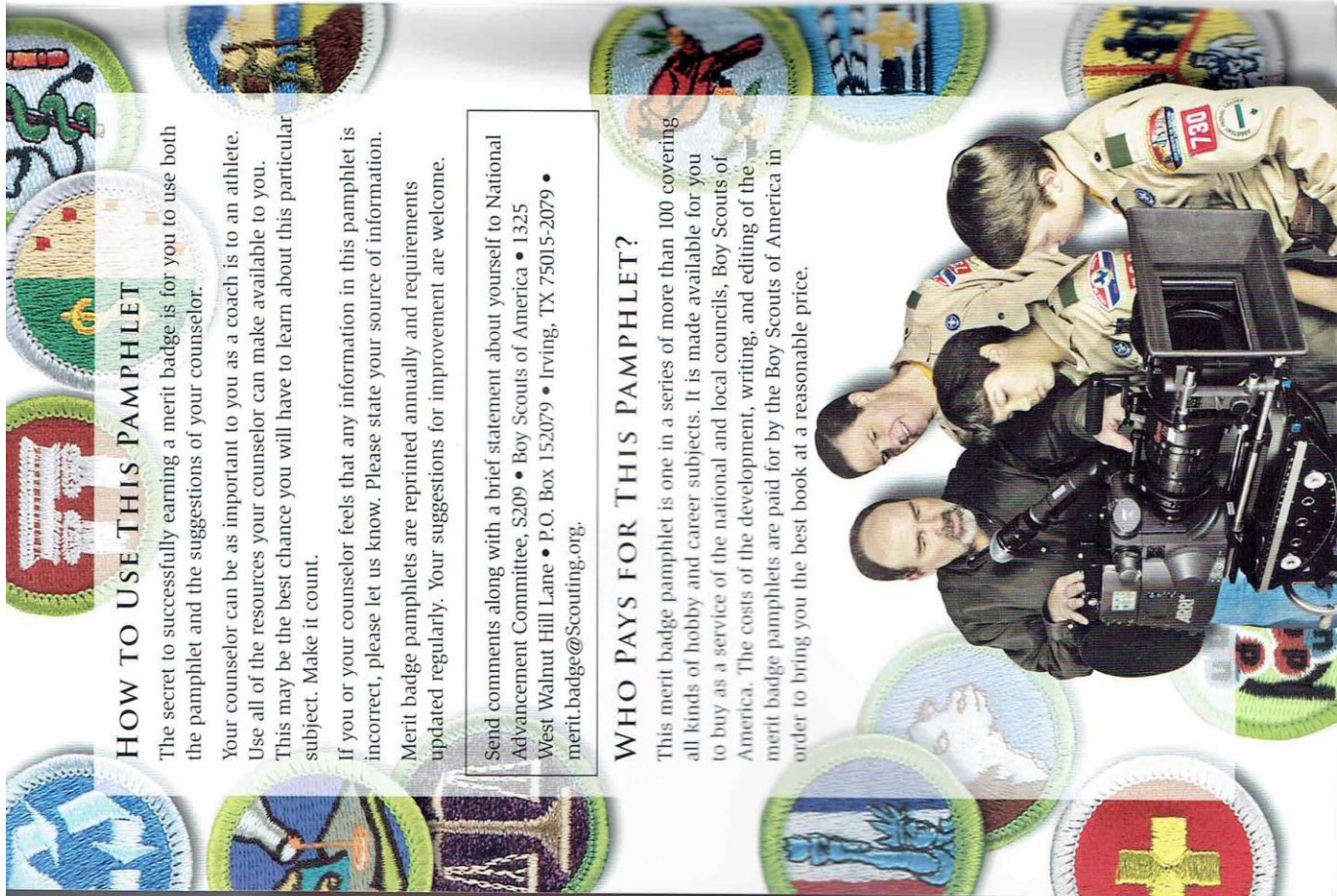



# Requirements

1. Explain what radio is. Then discuss the following:
  - a. The differences between broadcast radio and hobby radio
  - b. The differences between broadcasting and two-way communications
  - c. Radio station call signs and how they are used in broadcast radio and amateur radio
  - d. The phonetic alphabet and how it is used to communicate clearly
2. Do the following:
  - a. Sketch a diagram showing how radio waves travel locally and around the world. Explain how the broadcast radio stations WWV and WWVH can be used to help determine what you will hear when you listen to a shortwave radio.
  - b. Explain the difference between a DX and a local station. Discuss what the Federal Communications Commission (FCC) does and how it is different from the International Telecommunication Union.
3. Do the following:
  - a. Draw a chart of the electromagnetic spectrum covering 100 kilohertz (kHz) to 1,000 megahertz (MHz).
  - b. Label the MF, HF, VHF, UHF, and microwave portions of the spectrum on your diagram.
  - c. Locate on your chart at least eight radio services, such as AM and FM commercial broadcast, citizens band (CB), television, amateur radio (at least four amateur radio bands), and public service (police and fire).
4. Explain how radio waves carry information. Include in your explanation: transmitter, receiver, amplifier, and antenna.
5. Do the following:
  - a. Explain the differences between a block diagram and a schematic diagram.
  - b. Draw a block diagram for a radio station that includes a transmitter, amplifier, microphone, antenna, and feed line.
  - c. Explain the differences between an open circuit, a closed circuit, and a short circuit.
  - d. Draw eight schematic symbols. Explain what three of the represented parts do. Find three electrical components to match to three of these symbols.
6. Explain the safety precautions for working with radio gear, including the concept of grounding for direct current circuits, power outlets, and antenna systems.
7. Visit a radio installation (an amateur radio station, broadcast station, or public service communications center, for example) approved in advance by your counselor. Discuss what types of equipment you saw in use, how it was used, what types of licenses are required to operate and maintain the equipment, and the purpose of the station.



8. Find out about three career opportunities in radio. Pick one and find out the education, training, and experience required for this profession. Discuss this with your counselor, and explain why this profession might interest you.

9. Do ONE of the following (a OR b OR c):

a. AMATEUR RADIO

- (1) Tell why the FCC has an amateur radio service. Describe some of the activities that amateur radio operators can do on the air, once they have earned an amateur radio license.
- (2) Using proper call signs, Q signals, and abbreviations, carry on a 10-minute real or simulated amateur radio contact using voice, Morse code, or digital mode. (Licensed amateur radio operators may substitute five QSL cards as evidence of contacts with amateur radio operators from at least three different call districts.) Properly log the real or simulated ham radio contact and record the signal report.
- (3) Explain at least five Q signals or amateur radio terms you hear while listening.
- (4) Explain some of the differences between the Technician, General, and Extra Class license requirements and privileges. Explain who administers amateur radio exams.
- (5) Explain how you would make an emergency call on voice or Morse code.
- (6) Explain the differences between handheld transceivers and home "base" transceivers. Explain the uses of mobile amateur radio transceivers and amateur radio repeaters.



# ON AIR

b. BROADCAST RADIO

- (1) Prepare a program schedule for radio station "KBSA" of exactly one-half hour, including music, news, commercials, and proper station identification. Record your program on audiotape or in a digital audio format, using proper techniques.
- (2) Listen to and properly log 15 broadcast stations. Determine the program format and target audience for five of these stations.
- (3) Explain at least eight terms used in commercial broadcasting, such as segue, cut, fade, continuity, remote, Emergency Alert System, network, cue, dead air, PSA, and playlist.

c. SHORTWAVE LISTENING

- (1) Listen across several shortwave bands for four one-hour periods—at least one period during daylight hours and at least one period at night. Log the stations properly and locate them geographically on a globe.
- (2) For several major foreign stations (BBC in Great Britain or HCJB in Ecuador, for example), list several frequency bands used by each.
- (3) Compare your daytime and nighttime logs; note the frequencies on which your selected stations were loudest during each session. Explain differences in the signal strength from one period to the next.



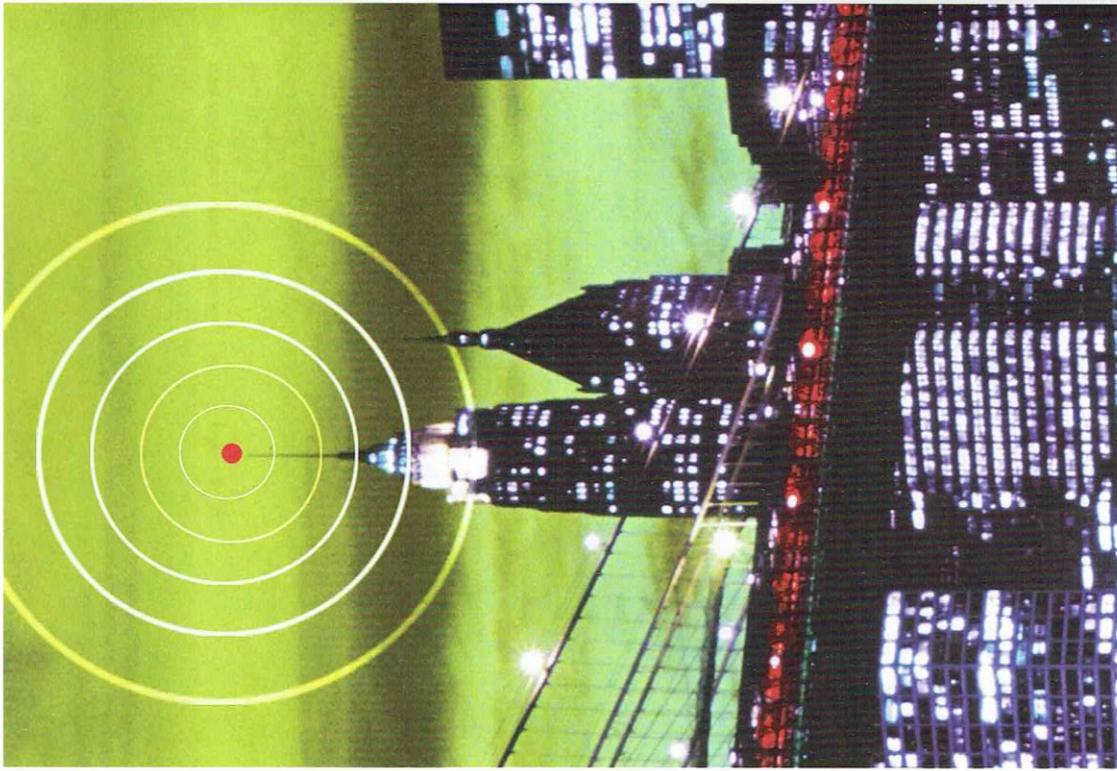

## Contents

Adventure on the Airwaves . . . . .	9
What Is Radio? . . . . .	13
Schematics: The Code of Electronics . . . . .	31
Safety Precautions . . . . .	41
Building Project . . . . .	45
Amateur Radio . . . . .	51
Broadcast Radio . . . . .	69
Shortwave Listening . . . . .	81
Careers in Radio . . . . .	89
Radio Resources . . . . .	93



## Adventure on the Airwaves

Picture yourself as an astronaut on the International Space Station, talking by radio to Mission Control. Or as a radio news reporter or a police officer racing to a crime scene. Or as a storm chaser monitoring weather-spotter reports on ham radio. All these images share one thing: your interest in radio, either as part of work or as a hobby.



While in orbit, NASA astronaut Tom Marshburn (KE5HOC) used the radios of the International Space Station to communicate with Johnson Space Center in Houston. As an amateur or "ham" radio operator, he also used ham radios to connect with students across the United States through the ARISS (Amateur Radio on the International Space Station) program.



## The World of Radio

With a ham radio license, you might talk to country music singer Patty Loveless (KD4WUJ), or to a licensed astronaut aboard the International Space Station. You might talk to an Israeli Scout during Scouting's Jamboree-on-the-Air. As a short-wave listener, you can eavesdrop on Coast Guard helicopters shadowing a drug runner in the Caribbean. You can listen to Voice of America, the international radio network of the United States, and compare it to Radio Beijing's version. You can get the exact time from the National Institute of Standards and Technology's radio station WWV, or find out the weather in France by listening in on airliners flying 40,000 feet over Europe.

People use radio signals to control everyday items from model cars and airplanes to automatic garage door openers and the door locks on their cars. The U.S. Border Patrol and the Army use radio signals to control unmanned aerial vehicles (UAVs), which broadcast television pictures back to the ground. Pilots and sailors count on radio signals from the satellites of the Global Positioning System (GPS) and land-based LORAN and VOR transmitters to help them navigate safely through the air and oceans.

**LORAN** stands for **Long-Range** Navigation.  
**VOR** is short for **Very-high-frequency (VHF)** Omnidirectional **Range**, a short-range navigation system.

You use radio in some way every day. You might listen to satellite news from another country, ride in a bus equipped with a business-band radio, watch educational television at school, watch a police officer with a walkie-talkie at the scene of an accident, or text-message a friend on a cell phone.



When you have earned this merit badge, you will know a lot about radio. You may even have found a lifelong hobby or career. Let's get started.

## Your Choice From Three Options

To complete the Radio merit badge requirements, you will choose one of these three options to learn more about: amateur radio, broadcast radio, or shortwave listening. This pamphlet gives details about each.

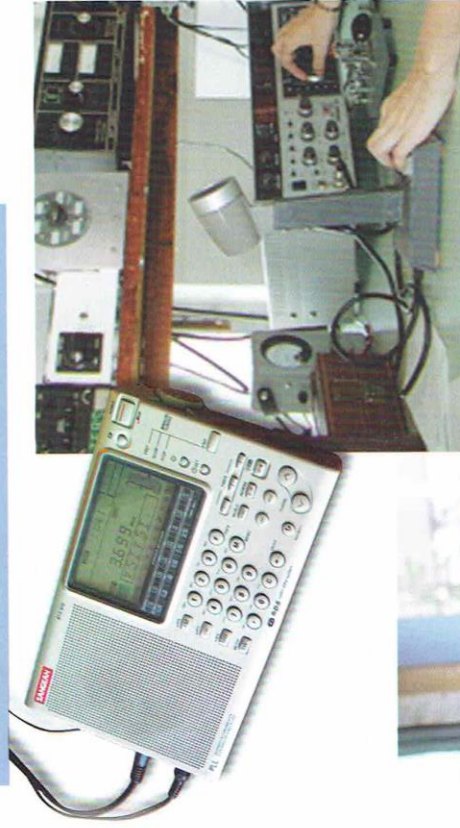



## What Is Radio?

In England radio is called “wireless”—a good word for it. Radio is the use of electrical waves to send and receive information—“communications”—from the transmitter to the receiver, without wires connecting the two places. The places might be far apart (a TV transmitter on a satellite orbiting Earth, and a receiver in your living room) or quite close (a key fob on your key ring and the remote door-lock receiver in your car).

**Broadcasting** uses radio to send information to lots of people at the same time. The information might be just voices and music (as in AM or FM or shortwave broadcasting), or it might also include pictures transmitted along with the sound (television).

**Hobby radio** is the use of radio by ordinary people—ham radio operators “working DX” or citizens band operators with radios in their 18-wheelers, model aircraft or boat enthusiasts who control their craft by radio remote control, model-rocket builders who send television transmitters up on their rockets, even your Scout troop using Family Radio Service (FRS) portable radios to keep in touch while hiking.

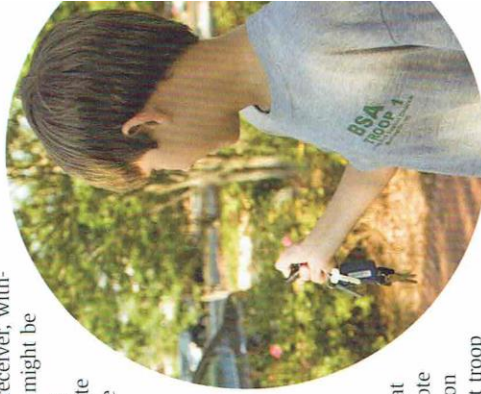

**Broadcasting is one-way radio—** a transmitter sends transmissions to many receivers, but the receivers can't reply. With two-way radio, however, there is a transmitter and receiver at both ends so that messages can travel both ways.



## Licenses

In the United States, radio transmitters are regulated by an agency of the federal government called the Federal Communications Commission, or FCC. Other countries have agencies that serve the same purpose. These agencies issue permission for the use of radio waves. The legal paper granting this permission is called a *license*.

In some types of radio (“services”), every transmitter has a license. For example, all broadcasting stations are required to be licensed. An organization might have a license to cover all of its transmitters. Your local police department would have one license for its base station and all of the radios in its cars and handheld radios used by its officers.

In other types of radio, some central transmitters are licensed, but others are not. For example, phone companies need licenses for their cell phone sites, but individual cell phone users are not licensed. In the amateur radio service, the radios themselves are not licensed, but the operators (“hams”) have licenses to operate any ham radio within the limits of their license class.



## Call Signs

Licensed transmitters (or, in the amateur radio service, operators) are assigned a “name” by the FCC when they are issued their license. This name is usually a combination of letters, or letters and numbers, called a *call sign*. Each radio service has different rules for what call signs look like and how often they must be transmitted.

Call signs for U.S. broadcasting stations have either three or four letters—for example, WOR in New York City, or KABC in Los Angeles. Call signs for broadcasters east of the Mississippi River start with the letter *W*, and broadcasters

west of the Mississippi River start with *K*. There are a few exceptions, such as Pittsburgh’s KDKA or WFAA in Dallas, but most follow the rule. Broadcast stations in the United States are required to identify themselves with their call signs on the hour; most will do so several times each hour.

A broadcaster may have several stations in different broadcasting services using the same call sign, in which case the letters *AM*, *FM*, or *TV* follow the call sign. WSKG-FM is used by public radio in Binghamton, New York, and WSKG-TV is the public television station. Some radio stations networks may have related call signs, as in WJIV, WBIV, WSIV, and a few others that once made up the “ivy” network in central New York.

## Ham Call Signs

In the amateur radio service, each set of calls is unique. The beginning (*prefix*) of the call sign indicates the country: W, K, N, or A for the United States; VE for Canada; XE for Mexico, for example. In the United States the first letter may be followed by another letter, then always by a number, which tells you where the ham was first licensed (the *call district*). These numbers are assigned roughly clockwise around the country, starting with 1 for New England, 2 for New York or New Jersey, 3 for the mid-Atlantic states, and so on, to 9 and 0 in the Midwest. Canadian ham call signs use a similar system, going from east to west with VE1 in Nova Scotia and VE7 in British Columbia.

If a ham moves to another call district, his call sign does not change. So if you hear a “W6” he might be in California, or he might have received his call letters when he lived there but is now living in Maine.

The last one to three letters are usually assigned alphabetically from the unused combinations at the time the call sign was issued. In most cases the *suffix* letters following the number are meaningless. In the past, some organizations were able to get special call signs, like the Boy Scouts of America’s ham radio station K2BSA, or the Smithsonian’s NN3SI. The FCC now has a “vanity call sign” procedure. For a fee, a ham may request a specific call sign if it is not assigned to someone else. Many Scouters have calls with “BSA” suffixes. Many hams have come up with sayings to make their call signs easier to remember, such as “K two little furry bunnies” for K2LFB.

Canadian broadcasting stations

have call signs

starting with **C**,

as in CFAX in

Vancouver or

CBN in St. John’s,

Newfoundland.



### Here are some common prefixes:

- W, K, N, A—United States
- VE, VO, XJ—Canada
- XE—Mexico
- PY—Brazil
- G—Great Britain
- F—France
- I—Italy
- 4X, 4Z—Israel
- JA—Japan
- ZL—New Zealand

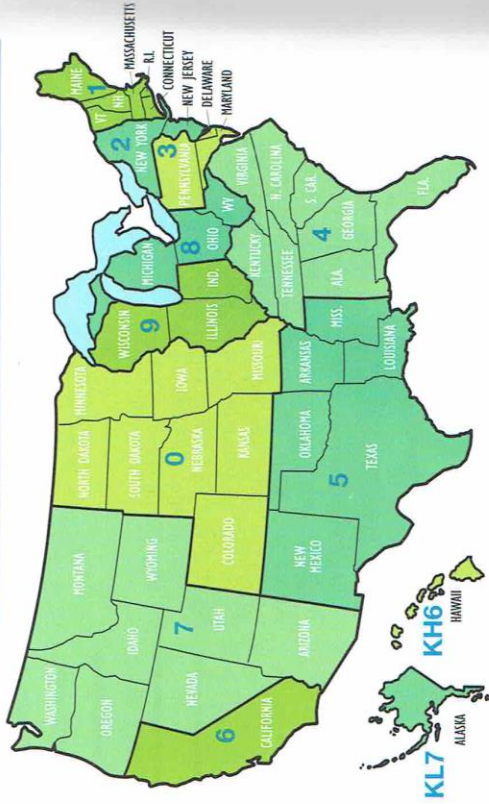

This map shows what number will be in your amateur radio call sign, depending on where you live when you first get your license. For example, if you live in California, your call sign will contain a 6. You will keep that call sign even if you move to another call district.

### Phonetic Alphabet

Many letters sound similar. Over the radio it can be hard to make out the differences between C, E, V, and Z, or B, P, and T, or S and F, and so on, especially when a radio station is weak or there is static. Things can get even more confusing when one of the operators is more familiar with the alphabet the way it is pronounced in another language. In Spanish, for instance, the letter E is pronounced like a long A, as in *day*. So if you hear a ham in Mexico say a long A, which letter does he mean?

To help make themselves understood, radio operators use a *phonetic alphabet*. A phonetic alphabet uses a word to stand for each letter the operator is trying to get across. If your name is Ted, you would spell your name as “Tango Echo Delta.” If it is Dan, you would say “Delta Alfa November.” If there is static and you spelled out your name only as “D-A-N” instead of saying “Delta Alpha November,” the listener might hear “B-E-N.” Many letters sound alike when the signal is hard to hear.

Many phonetic alphabets have been used over the years, and the military uses its own system. Most civilian radio users now use the following standard set by the International Telecommunication Union (ITU) and International Civil Aviation Organization (ICAO):

### Standard ITU/ICAO Phonetics

This list of words is used for the phonetic alphabet.

- A—Alfa (AL-fah)
- B—Bravo (BRAH-yoh)
- C—Charlie (CHAR-lee or SHAR-lee)
- D—Delta (DELL-tah)
- E—Echo (ECK-oh)
- F—Foxtrot (FOKS-trot)
- G—Golf (GOLF)
- H—Hotel (hoh-TELL)
- I—India (IN-dee-ah)
- J—Juliet (JEW-lee-ett)
- K—Kilo (KEY-loh)
- L—Lima (LEE-mah)
- M—Mike (MIKE)
- N—November (no-VEEM-ber)
- O—Oscar (OSS-cah)
- P—Papa (PAH-pah)
- Q—Quebec (keh-BECK)
- R—Romeo (ROW-me-oh)
- S—Sierra (see-AIR-rah)
- T—Tango (TANG-go)
- U—Uniform (YOU-nee-form or OO-nee-form)
- V—Victor (VIK-tah)
- W—Whiskey (WISS-key)
- X—Xray (ECKS-ray)
- Y—Yankee (YANG-key)
- Z—Zulu (ZOO-loo)



## How Radio Waves Travel

Radios use AC, or alternating current, like the electricity that comes from the outlets in your house. (You may also be familiar with DC, or direct current, as is produced by batteries.) The AC electric power that lights your room reverses or *alternates* from positive to negative and back, 60 times each second. We can say its frequency of alternating is 60 times (cycles) per second, or 60 hertz.

As the frequency of alternating current gets higher than about 10,000 hertz, the signal no longer wants to stay in the wire. Thus, at frequencies above 10,000 Hz, alternating current becomes *radio frequencies*, or RF. If the length of the wire is right, the signal leaves the wire (now an *antenna*) and goes through the air, like the light from a lightbulb. As you read this, millions of those signals are zipping through your body (luckily they don't tickle).

Think about that lightbulb for a minute. If you are standing close enough, you see the glow of the bulb. Even if you can't see the bulb itself, you might see its light shining on the walls of the room. What if the bulb were behind your house? You could still see its light reflected off the picture window in the house next door.

Radio signals travel the same way as the light from the bulb. If your receiving antenna can actually "see" the transmitting antenna, you will receive the signal directly. This is called *line-of-sight reception*, and that is how very high frequency (VHF) and ultra high frequency (UHF) signals are most often received.

Most local radio reception, especially on the AM radio broadcast band during the day, is like seeing the bulb scattering light from the walls of the room. This is called *ground wave* because the signal hugs the ground, traveling along Earth's surface.

A band is a range of frequencies. AM radio stations transmit within the medium-wave band from 535 to 1605 kHz. The shortwave band ranges from 3 to 30 MHz. FM stations transmit within a very high frequency (VHF) band from 88 to 108 MHz.

How can you explain being able to hear a distant station when your receiving antenna is too far away to "see" the transmitting antenna? Just as the lightbulb reflects from the window next door, so radio waves seem to reflect from a "mirror" in the sky—the layers of air between 40 and 300 miles up called the *ionosphere*. Radio waves may bounce ("skip") from the ionosphere back to Earth, and up again, all the way around the world.

The ionosphere is made up of air that is electrically charged by the sun and shaped by Earth's magnetic field. Radio waves entering the layers of the ionosphere can be bent and reflected back to Earth, or they can be absorbed by the ionosphere, or they may pass through the ionosphere, depending on the radio frequency and the height and thickness of the ionosphere's layers. The height and thickness of the layers will change as the angle and amount of sunlight changes over the day and the seasons of the year.

The layers are also affected by variations in the sun's light caused by sunspots and other effects. This is why the distance a radio transmitter may be heard (propagation) varies with the time of day, season, and the 11-year sunspot cycle.

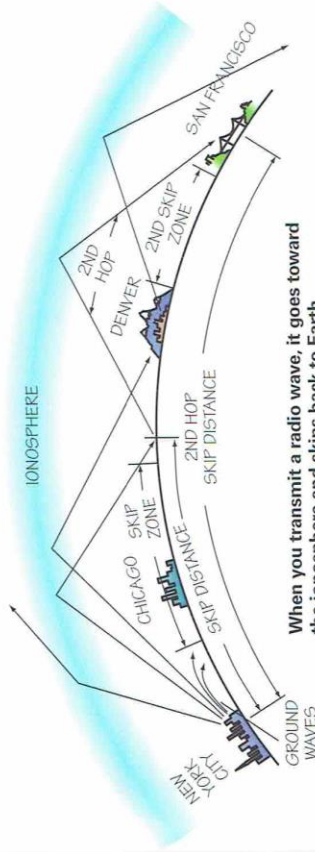

When you transmit a radio wave, it goes toward the ionosphere and skips back to Earth.

As a rule, signals in the AM broadcast band (535 kHz to 1605 kHz) are limited to the relatively short distances of ground-wave propagation during the day, since this is when the lower layers of the ionosphere are thickest and absorb the signals. At night, these layers become thinner, and the AM signals can pass through and be bent to "skip" down much farther away.



On the other hand, signals in the range of about 10 MHz to 30 MHz are bent by this thicker daytime layer, so they are useful for worldwide communications during the day. But at night, as the layer thins, it becomes too thin to bend the waves, and these signals are no longer capable of long-distance “skip.”

### Knowing the Propagation

A good check of radio propagation (the ability of radio signals to travel from one place to another) is to listen to radio station WWV in Colorado, or its sister station WWVH in Hawaii, operated by the National Institute of Standards and Technology (NIST). These stations broadcast on exact frequencies of 2.5, 5, 10, 15, and 20 MHz—frequencies in the *shortwave* radio spectrum.

The stations transmit a continuous “beep-beep” at one-second intervals, with a voice identification of each station’s call sign each minute, sometimes with additional information including time corrections, “space weather” reports such as solar storms that affect radio communications, marine storm warnings, and Global Positioning System (GPS) status reports. WWVH identifies at 15 seconds before the minute, WWV immediately afterward. By tuning to each of the WWVH and WWV frequencies, a listener can get a good idea of how loud signals on these radio frequencies will be from ham radio stations or other radio services located in the West and the Pacific areas.

**International time stations like CHU in Ottawa, Canada, and WWV in Fort Collins, Colorado, below, are scattered around the world. By knowing the propagation, you can choose the band to listen to that is best for the distance that interests you.**



### What Is DX?

Radio stations that are not local to your area are called DX, the Morse code abbreviation for “distance.” It isn’t possible to provide a definition of DX as a number of miles, so that you could measure on a map when a station becomes DX. In some ham radio bands, like the 20-meter band at 14.0 to 14.35 MHz, where normal propagation is in the thousands of miles, a DX station usually is considered to be anyone outside your home country. In other bands like the 2-meter band at 144 to 148 MHz, where normal propagation is very short range, a station in the next state might be “DX.” In any case, you can tell the DX station because it is the one everyone is likely trying to reach.

### The FCC and the ITU

When radio began, the radio frequency spectrum was not regulated. Each user built a station and got on the air. The result was a mess. Even worse, the earliest “spark gap” radio transmitters simply used a big spark to create static, which was turned on and off to form the dots and dashes of Morse code characters. Each transmitter’s “frequency” depended on its antenna’s length, but basically every transmitter’s signal was heard everywhere up and down the bands. Two Scouts talking across town on homemade transmitters could interfere with ships at sea—and anyone else trying to communicate.

Spark was outlawed in the 1920s, which helped some. At the same time, radio broadcasting became popular and broadcast stations began to multiply like weeds. Everyone wanted to start a radio station. Without regulation, that is just what they did.

Finally, the world’s countries got together to divide the radio spectrum into bands or groups of frequencies. Each band is assigned to one or more services or types of users, such as military or government use, broadcasting, amateur (ham) radio, etc. In this country, a U.S. government agency, the Federal Communications Commission (FCC), was formed in 1927 (it was called the Federal Radio Commission back then). The commission became responsible for regulating the use of these bands by users in the various radio services within the United States.



Today, the FCC regulates who gets to use what frequencies, and issues licenses to radio stations, transmitters, and operators. In each service, the FCC decides which users require licensing. For example, amateur service operators must take an FCC test to get their “ham” licenses, while in the broadcasting service each transmitter is licensed, but the on-the-air personality at the microphone does not need a license.

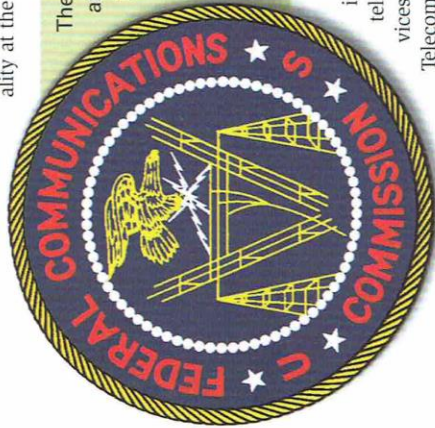

The FCC is responsible for setting and enforcing technical standards for anything that generates radio frequencies. Look at your CD player or garage door remote control; you may find a label saying it complies with FCC rules.

The FCC does not have authority outside the United States. Global telecommunications networks and services are coordinated by the International Telecommunication Union (ITU), headquartered in Geneva, Switzerland.

“The ITU Radiocommunication Sector (ITU-R) plays a vital role in the global management of the radio-frequency spectrum and satellite orbits—limited natural resources which are increasingly in demand from a large and growing number of services such as fixed, mobile, broadcasting, amateur, space research, emergency telecommunications, meteorology, global positioning systems, environmental monitoring, and communication services—that ensure safety of life on land, at sea, and in the skies.”

—<http://www.itu.int/ITU-R>



## How Radio Waves Carry Information

A pure radio signal does not convey any information; it’s just there. While a continuous radio signal might be of some use as a homing beacon, if you want to communicate using radio you must find a way to put information onto the signal.

### Morse Code

Spelling out words by Morse code is fun and useful. The simplest way to put information on the signal is to turn it on and off in a recognizable pattern or code. That is exactly what ham operators do when using Morse code—they turn a simple continuous wave (CW) produced by a transmitter on and off in a series of long and short transmissions. Then, someone using a receiver detects whether the signal is there or not, and figures out from the pattern what was said.

Hams use the words *dit* and *dah* to represent the short and long sounds of the Morse code. The letter A is “di-dah,” B is “dah-di-di-dit,” C is “dah-di-dah-dit,” and so on. Morse code works well under poor conditions for listening and hearing. The human ear is good at translating faint beeps amid static into letters. However, Morse code is a slow means of communication (15 to 20 words per minute is typical of on-the-air conversations), and machines have trouble interpreting the varying-length letters and spaces.

### Modulation

Before long, people wanted to transmit sounds (audio) over the radio—that is, voices and music. To do that, you must combine the audio with the continuous radio signal (the *carrier*). This combination of audio and carrier is called *modulation*.

There are basically two ways to modulate a carrier with sounds or other signals. You can change the strength (amplitude) of the signal, which is called *amplitude modulation* or AM. Or you can change the frequency of the signal, which is called *frequency modulation* or FM. (Now you know what the AM and FM on your clock radio mean.) Television is a combination of AM (for the picture) and FM (for the sound).



Ham radio operators use a variety of amplitude modulation called *single sideband* (SSB) on the shortwave bands, and mostly FM on the VHF and UHF bands. *Citizens band* radios are mostly AM (although some use SSB, too). *Family Radio Service* (FRS) handheld radios use FM, as do most police and fire radios.

Today, more and more communications signals are being sent digitally. Digital satellite radio and television have been around for some time, and digital broadcast radio and TV are starting to replace the older AM and FM systems. Digital mobile phones have completely replaced the original analog cell phone system. All of these digital radio and TV systems, whether the signals are sent by satellites or earthly transmitters, use a system of shifting transmit frequency to send binary numbers—"ones" or "zeroes." They shift very quickly. Computers on each end can translate sound and pictures to digital numbers and back again without interrupting the show you are watching or listening to.

### Analog vs. Digital

Ordinary voice, radio, and television signals are analog; the signals range over a continuous spectrum of values. Think of a glass thermometer that uses a column of mercury to indicate the temperature. The mercury continually rises and falls with changes of temperature. Compare that to a digital thermometer that shows the temperature in distinct numerical digits rather than by a continuously moving liquid. Analog communications signals can be digitized to be transmitted as the binary digits ("bits") 1 and 0.

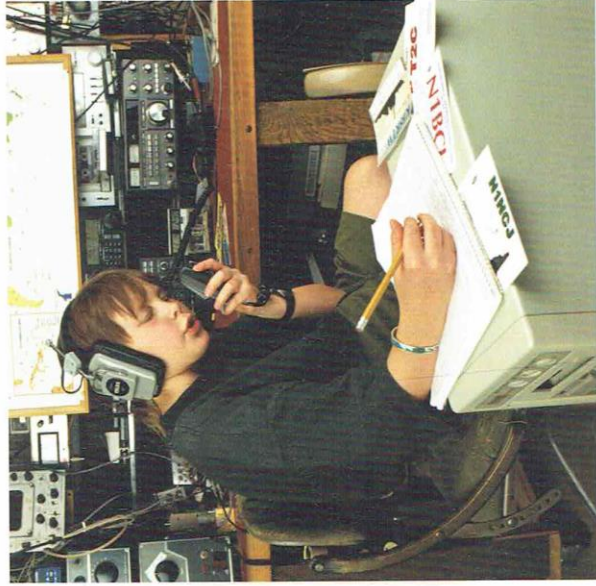

### Radio Communications: Basic Equipment

Let's look at a ham operator talking to a friend on the other side of the world, and see what parts are required. He talks into a microphone, which turns his voice into electrical energy, which the transmitter part of his transceiver uses to modulate the radio-frequency carrier. The modulated signal is sent to the antenna along a feed line and leaves the antenna as a radio signal. If the operator wants a more powerful signal, he can amplify it by using an amplifier between the transceiver and the antenna.

At the receiving station, the process happens in reverse. The receiving antenna picks up the radio signal. The signal goes down a feed line to another transceiver, where a radio frequency (RF) amplifier in the receiver part makes it strong enough to hear (the signal at the antenna can be very weak—maybe several millionths of a watt). Then, a detector extracts the audio part of the signal. The audio frequency (AF) energy is amplified by another amplifier, and a speaker reproduces the sound for the receiving operator to hear.

A transmitter and receiver combined in one box is called a *transceiver*.



The most efficient length for an antenna is related to the wavelength of the signal. The towers used at broadcast stations, or the whip antennas on police cars, are most often one-quarter or five-eighths of a wavelength tall. A horizontal *dipole* antenna is often used by ham radio operators. It's a simple wire, one-half wavelength long.

Antennas with several elements, called "yagis" (*yag-ez*) or "beams," allow the signal to be sent or received in one direction better than others. These antennas are used for TV reception, where the TV transmitter is far away, or on a rotator by ham operators so they can direct their signal to the part of the world they want to communicate with.

Operation on the amateur radio 160-meter frequency band needs an antenna 80 meters (240 feet) long. That takes a pretty big yard!

### The Electromagnetic Spectrum

The *electromagnetic spectrum* is the range of frequencies from DC through audio, radio, and light waves (infrared to visible light to ultraviolet), X-rays, and gamma rays. For the Radio merit badge, you will be interested in the radio part of the spectrum—around 0.1 MHz to 10,000 MHz.

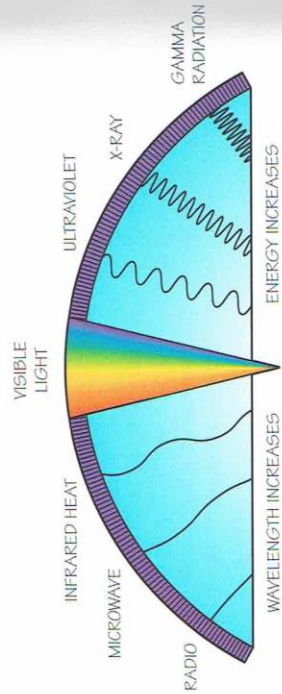

The electromagnetic spectrum

You will also see the prefix *giga* (G) used with frequencies. Giga means one billion, so 1.0 GHz is 1,000 MHz. Commonly used metric words (prefixes) for fractions are *milli* (m), one thousandth, and *micro* ( $\mu$ ), one millionth.

Radio waves travel through space at the speed of light (186,000 miles per second). The distance a radio signal travels in one cycle (positive to negative and back again) is called its *wavelength*. The higher the frequency, the shorter the wavelength. Ham operators and shortwave listeners (SWLs) usually use the wavelength of signals to group radio frequencies into bands. Signals on the 20-meter ham radio band, for instance, have wavelengths of about 20 meters (66 feet).

The radio spectrum is divided into ranges.

Low frequency (LF)	30 to 300 kHz
Medium frequency (MF)	300 to 3,000 kHz
High frequency (HF), also known as shortwave	3 to 30 MHz
Very high frequency (VHF)	30 to 300 MHz
Ultra high frequency (UHF)	300 to 3,000 MHz
Super high frequency (SHF)	3 to 30 GHz
Extremely high frequency (EHF)	30 to 300 GHz

Microwaves have frequencies higher than about 1,000 MHz (1 GHz), which includes much of the UHF range and all of the SHF and EHF.

Look at all of the radios in your home and car to see what radio frequencies you can hear.



The Radio Spectrum

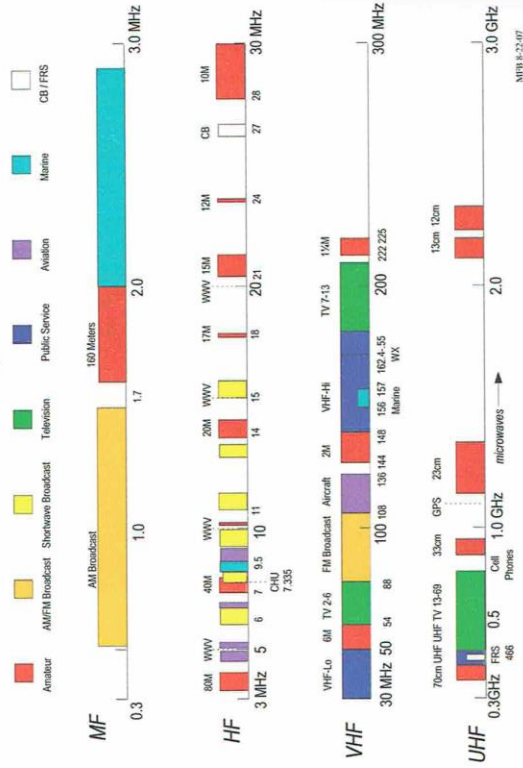

Look at the spectrum chart shown here. It shows where the various users of the radio spectrum ("services") fit. You should be able to locate at least eight of these services for your merit badge counselor. Locate the services that best match the option you choose in requirement 9 for the Radio merit badge. That is, if you choose the amateur radio option, you will find it most helpful to locate the various amateur radio bands.

Most radio services are located in a given area of the spectrum because something about the signals used by the service needs to be in that spot. For example, shortwave broadcasting is on several HF bands so that long-distance broadcasts to most of the world can be made 24 hours a day. Police are on VHF and UHF because these bands generally are good only for the short-range work of police radio needs. Cell phones are in the UHF and SHF spectrum, because the cell phone system works by keeping the range of any base station ("cell") short, so that the frequencies can be reused by another nearby cell—which is why you see so many cell phone towers along every highway. Other radio services are where they are for purely historical reasons.

To see a detailed spectrum chart with all of the frequency allocations for the United States, visit <http://www.ntia.doc.gov/osmhome/alloc.htm>, website of the National Telecommunications and Information Administration, Office of Spectrum Management. Be sure to get your parent's permission first.

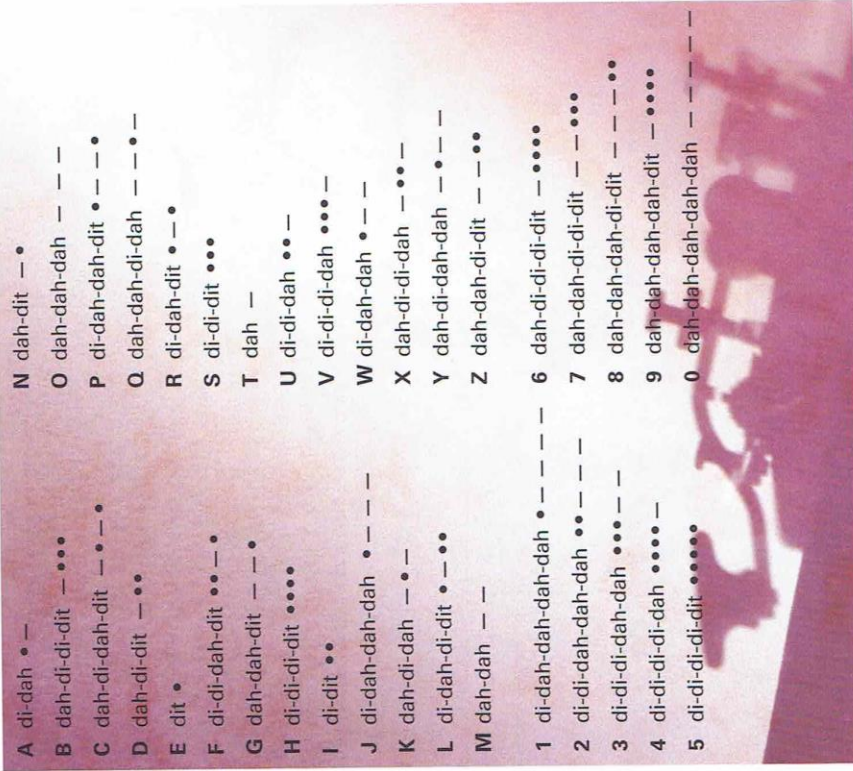

Many ham radio operators use Morse code, a sort of secret language. These short and long sounds (*di, dit, dah*) are formed when the switch (key) opens or closes the electrical circuit.



# Schematics: The Code of Electronics

A *block diagram* shows a system by diagramming it as connected boxes (blocks). The blocks are usually major parts of the system. In this block diagram, for example, the boxes represent a transmitter, a receiver, an amplifier, an antenna, and a speaker.

The *transceiver* is a device that combines a *transmitter* (to send radio signals) and a *receiver* (to receive radio signals). An *amplifier* makes the transmitted signals stronger. The *antenna* receives radio signals from the air and sends them into the air, or picks up signals from the air for the receiver to decode. The *feed line* is a cable that connects the transceiver to the antenna.

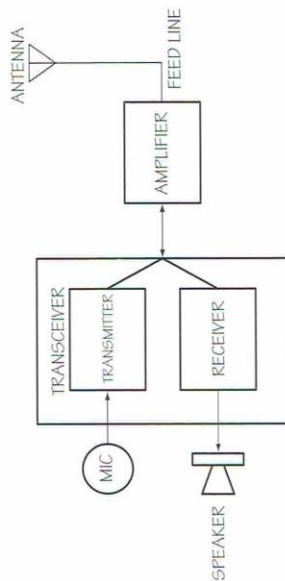

**This block diagram shows the parts of a typical amateur radio station.**

A *schematic diagram* or “schematic” of an electrical circuit is a drawing that shows how that circuit is built. While the blocks in the block diagram show major systems, a schematic shows how individual electronic parts are put together to form a system. In many cases, you may have both a block diagram and a schematic of the same system.



For example, you could make a block diagram of a transmitter with three blocks showing an *oscillator* (which produces an alternating current of a certain frequency) feeding a carrier to a modulator, which modulates the carrier and feeds it to an amplifier, with lines between the boxes representing the carrier and the modulated signal. Or, you could draw a schematic of the transmitter showing the collection of electronic parts (*transistors*, *resistors*, *coils*, and *capacitors*—more about these later) that make up the oscillator, modulator, and amplifier, and the wires connecting them all.

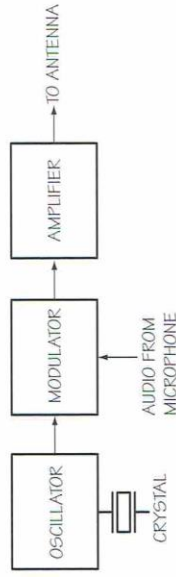

This block diagram shows a simple crystal-controlled transmitter.

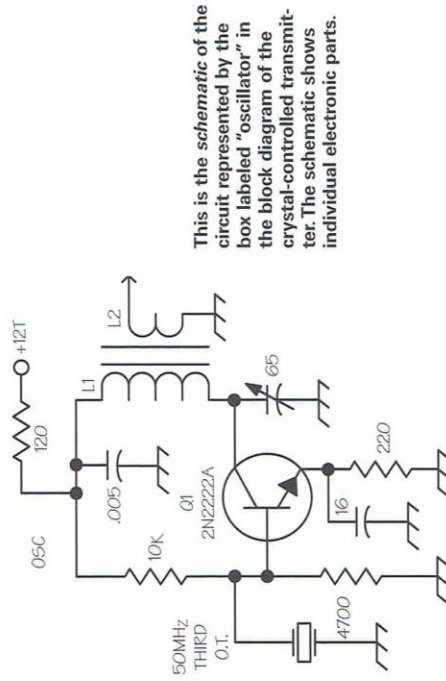

This is the schematic of the circuit represented by the box labeled "oscillator" in the block diagram of the crystal-controlled transmitter. The schematic shows individual electronic parts.

Like a map, a schematic uses symbols in place of actual drawings of electronic parts. A symbol is a picture that represents a thing, such as an image of an airplane on a map to mean an airport. To read a schematic, you need to know what the symbols represent.

## Ohm's Law

Before we look at some schematic symbols for electronic parts, you should be familiar with the basic law that governs electronics—Ohm's law, named after Georg Simon Ohm, a German scientist who first published his law in 1827. Ohm's law relates the three basic units of electronics: voltage, current, and resistance.

**Voltage**, also called *electromotive force* or EMF, is the force that causes electrons (negatively charged particles) to flow. It is measured in volts, and you can think of it like the water pressure that pushes water through a hose. The AA batteries in your flashlight supply 1.5 volts of direct current (DC). The large storage battery in a car supplies 12 volts to power the car's electrical system. The wall outlets in your room provide alternating current (AC) at 120 volts and a frequency of 60 hertz.

**Current**, measured in *amperes* (*amps*), is the quantity of electron flow. One amp is the flow of 6.25 billion billion (6.25 followed by 18 zeros) electrons per second. You can think of current as the amount of water flowing through a hose.

**Resistance** opposes ("resists") the flow of current. You can think of resistance as being like a sponge stuck in that water hose. It allows water to pass through, but not as easily as in an open hose. Resistance is measured in *ohms*. Substances such as metals that have very low resistance are called *conductors*. Substances like plastic or glass that have a very high resistance are called *insulators*.

Ohm's law is usually written as an equation. Using the units of voltage, current, and resistance, here is the formula:

$$\text{Volts} = \text{amps} \times \text{ohms}$$

Another way of saying Ohm's law in words is "voltage equals current times resistance."

We can use this formula to find voltage if current and resistance are known. For example, how much voltage is needed to force 2 amps of current to flow through 10 ohms of resistance? Twenty volts are required:

$$2 \text{ amps} \times 10 \text{ ohms} = 20 \text{ volts}$$



To find current if voltage and resistance are known, turn the formula around: Volts divided by ohms equal amps. How much current will flow in a circuit having 5 ohms of resistance when 15 volts are applied?

**15 volts ÷ 5 ohms = 3 amps  
A current of 3 amperes will flow.**

Finally, the formula can be rewritten to find resistance if voltage and current are known:

**Voltage ÷ current = resistance**

If 12 volts cause 4 amps of current to flow through a circuit, what is the resistance of the circuit?

**12 volts ÷ 4 amps = 3 ohms of resistance**

Using these formulas you can solve simple problems involving current, voltage, and resistance. There is one more basic quantity in electronics: *power*, the ability to do work. Power is measured in *watts*.

Power can be calculated using this formula:

**Watts = amps X volts**

With simple arithmetic you can determine the amount of power used by a circuit if the current and voltage are known. For example, how much power is used by a 120-volt toaster that draws 5 amps?

**5 amps X 120 volts = 600 watts**

Try another practical example. Suppose the outlet in your room is on a circuit that has a 15-amp fuse. Could you plug in a 1500-watt popcorn popper without blowing the fuse? The power-line voltage is 120 volts, you will remember. Do the calculation:

**1500 watts ÷ 120 volts = 12.5 amps**

Yes, you can plug in that popcorn popper—but only if you don't have 2.5 amps of other things already plugged in on the same circuit. How much is that? Do the math:

**2.5 amps X 120 volts = 300 watts**

That would be three 100-watt lights, or a 150-watt computer and a 75-watt monitor and a 75-watt desk lamp, or . . . you get the idea.

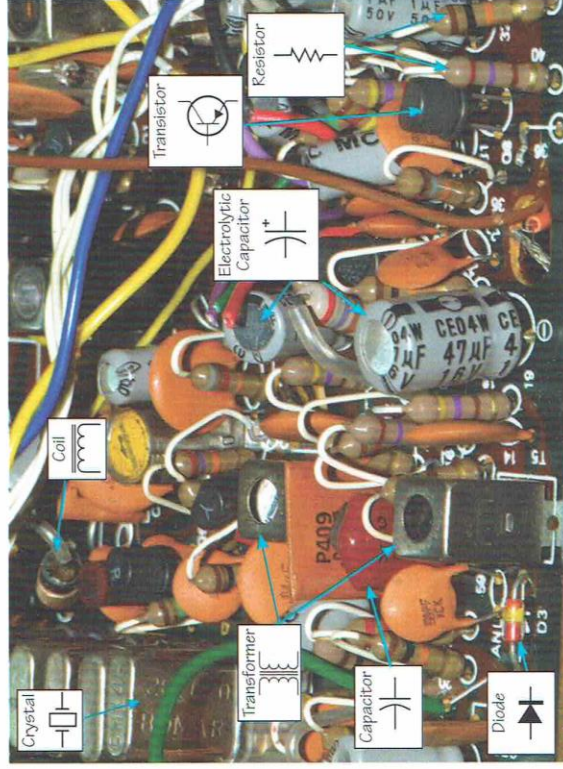

**Electronic components with the schematic symbols that represent various parts**

Now that you are familiar with Ohm's law and know about current, voltage, and resistance, let's look more closely at electronic components and schematic symbols.



## Resistors

Resistors are electrical parts that resist the amount of current that flows through a circuit. If you were to cut open most small resistors, you would find they are just a piece of carbon, like pencil lead. Other resistors have thin wire, which is why the schematic symbol for a resistor looks like a zigzag of wire.

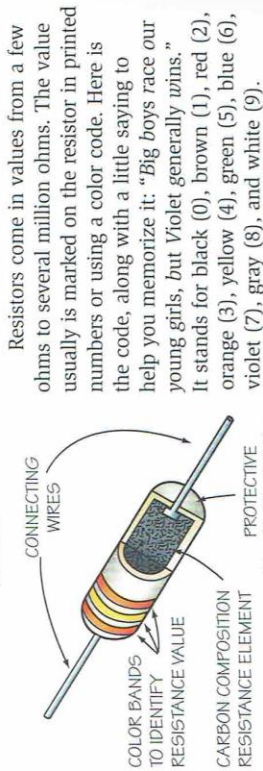

Resistors come in values from a few ohms to several million ohms. The value usually is marked on the resistor in printed numbers or using a color code. Here is the code, along with a little saying to help you memorize it: "Big boys race our young girls, but Violet generally wins." It stands for black (0), brown (1), red (2), orange (3), yellow (4), green (5), blue (6), violet (7), gray (8), and white (9).

**Resistors have bands of color, which let you figure their mathematical value. If you cut open a resistor, you would find it is made of carbon.**

One end of the resistor will have a color band. Counting from that end, the first two bands represent a two-digit number, and the third band gives the number of zeros after the two-digit number. If you had a resistor with yellow, violet (purple), and orange bands, for example, then its value would be 4 (first digit), 7 (second digit), and three zeros, or 47,000 ohms. If there is a fourth band, it tells you how accurate the value is.

A *variable resistor* is a resistor whose value can be changed. A variable resistor can act as a volume control on a radio, controlling the amount of power supplied to the speaker.

## Capacitors

A capacitor is two conductors separated by an insulator. Usually, a capacitor is formed of two metal or foil plates separated by plastic, waxed paper, or air. The amount of capacitance is measured in *farads*. The farad (F) is such a large quantity, however, that it is more common to see microfarad ( $\mu\text{F}$ ) or even smaller values on capacitors.

Capacitors are used to block the flow of direct current (DC) but allow alternating current (AC) to pass through an electrical circuit. In combination with resistors or coils (described below), they can form a *resonant circuit* in a filter to pass or block signals by frequency, or to determine the frequency of an oscillator.



**Schematic symbol for a capacitor**

Some large-value *electrolytic capacitors* are used in power supplies to store and release a charge, to smooth out ripples in the DC voltage from the supply. You can get a painful shock from the electrolytic capacitors in a power supply long after it was last used, so it is a good idea to know what they look like. Electrolytic capacitors are usually fairly large metal cylinders, compared to the small discs of other capacitors.



**Schematic symbol for a variable capacitor (Note the arrow.)**

A *variable capacitor* is a capacitor whose value can be changed. Variable capacitors are used in radio tuners or tunable filters, to change the frequency of a resonant circuit.

## More Electronic Components

A *choke*, or *coil*, is a coil of wire, sometimes wound around a core of ferrite (compressed iron dust) or metal. A choke works like the opposite of a capacitor. It blocks the flow of AC while allowing DC through.



IRON-CORE COIL

## Schematic symbols

A *diode* is like a check valve. It allows electrons to flow through in only one direction. If you used a solar panel to charge a battery, you might use a diode to be sure the battery did not run itself down through the solar panel at night when the sun was no longer out.



DIODE

*Transistors* are like faucets. A small turn on a faucet can start a large flow of water; a little current on the base of a transistor will control a much larger flow of electrons. Common types of transistors are PNP, NPN, and field effect transistors (FET). Older electronic equipment may use vacuum tubes, which work much like transistors.

Some diodes serve other purposes.

Light-emitting

diodes (LEDs),

for instance,

are the little

lightbulbs on the

front of electronic

equipment

like stereos.



**The Electronics**

merit badge  
pamphlet covers  
transistors  
and tubes in  
more detail.

**Schematic symbols for NPN and PNP transistors**

(Notice the arrow points in a different direction on each.)

An *integrated circuit*, or IC, isn't really an electronic component—it is lots of components all rolled into one small package. An IC can have thousands of transistors, resistors, and capacitors, all in a package a fraction of an inch on a side. ICs come in different shapes and sizes and can be as simple as a few transistors or as complicated as an entire computer. The central processing unit (CPU) on the computer you use is probably a single integrated circuit. Some ICs are sensitive to static electricity—you can ruin them just by touching the pins.

*Speakers* or headphones turn electrical energy into sound energy. Electrical current flowing through a coil moves a magnet attached to a cone made of paper or plastic, making the cone vibrate in time to the current. The cone moves air, and sound results.

*Transformers* are made of two or more coils of wire, wound around a common center. They pass AC signals from one coil to another without allowing DC current to pass. In a radio, transformers are mostly used to isolate one part of the circuit from another. Such transformers can be made to pass signals of certain frequencies, and block others. If the number of turns is the same in each coil, the AC signal will pass through at the same voltage. By varying the number of turns of one coil, the transformer can increase or decrease the voltage passed from one coil to the other.

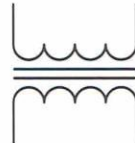
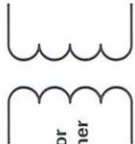
**Integrated circuit****Schematic symbol for a speaker****Schematic symbol for an iron core transformer****Schematic symbol for an air core transformer**

The black “brick” used to power a portable computer or charge a cell phone is mostly a transformer, used to step down the 120 volts on the power line to the 5 to 20 volts needed by the computer or phone.

*Crystals* are carefully cut pieces of quartz. By passing an electric current through the crystal, it can be made to vibrate at very exact frequencies. A *crystal oscillator* uses the vibrations of a crystal to produce extremely accurate radio frequency signals.

**Open, Closed, and Short Circuits**

A circuit is a path for electricity. It is important to remember that a circuit must be a complete path from a power supply, through some number of electronic parts, and back to the power supply. Sometimes the return path to the power supply from many different components might run through the case of the equipment or even a water pipe, or a rod stuck into the earth—which is why such a return path is called a *ground*.

A simple circuit might be a flashlight—just a battery, a switch, and a lightbulb, and the wires connecting them. When the switch is in the “off” position, there is no complete path for the electrons and you have an *open circuit*: No current flows through an open circuit. With the switch in the “on” position, you have a *closed circuit*: Current flows correctly through its path from the battery through the switch and lightbulb, and back to the battery.

A *short circuit* happens when the current flowing through the components doesn't follow the proper course. Instead, some flaw in the circuit causes the current to flow someplace else—say, to the equipment case or another wire. A short circuit can cause wires to overheat and even catch fire.

“When my rabbit, Scone MacBunny, bit through the power wire for my laptop computer, he caused a short circuit between the power wires, which created some very entertaining sparks. At least, they seemed to be fun for the rabbit.”

—Mike Brown, WB2JWD

**Schematic symbol for a ground connection**



## Safety Precautions

Operating a radio station is probably less dangerous than riding in a car. To stay safe, you need to think about safety. The following is a safety code based on guidelines from the American Radio Relay League, the national association of amateur radio operators. Read it and practice it.

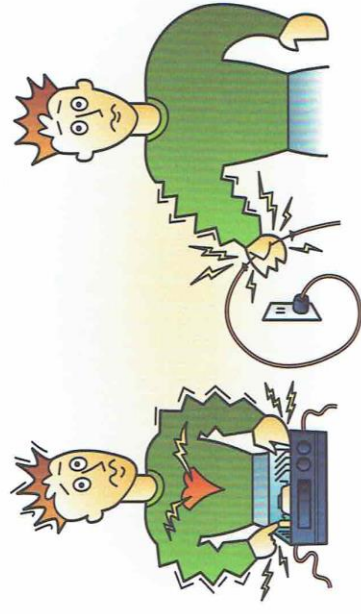

The most dangerous shock you can receive is one that goes from one hand to the other, directly through the heart. A current of as little as 10 milliamps (0.01 amps) can be fatal if it passes through your heart. Be very careful around any electrical power.

### Radio Safety Code

1. Unplug equipment before working on it and before touching anything behind or inside the radio.
2. Never let anyone turn the power on and off for you when you are working on a radio.
3. Do not work on a radio when you are tired or sleepy. Never work alone.





4. Never adjust internal electrical components bare-handed. Use the proper plastic or insulated tools, and be sure the insulation is in good condition.
5. To prevent your body from becoming the return path from a voltage source to the ground, don't touch grounded metal (like radiators or water pipes) or wet floors when you are working on radio equipment. Never handle equipment with wet hands—water is a good conductor.
6. Never wear headphones while working on radios.
7. Keep one hand in your pocket when working on radios. That way, if you do touch a "hot" point, the electricity cannot travel across your chest and cause a heart attack.
8. Tell your family how to turn the power off and how to give artificial respiration. Be sure you are up-to-date in first aid.
9. Take the time to be careful; death is permanent.

Electricity won't give you a break because you are a beginner. Develop good safety habits now so that you can enjoy your hobby for a long time.

Read and follow the manufacturer's advice for safety on a ladder. Think about each step before you take it. Test each step before putting your full weight on the rung. Follow the three-point rule: Keep three parts of your body (two feet and a hand, or two hands and a foot) in contact with the ladder at all times. Also, be cautious about loose roof shingles, which can pull out and cause a fall.



## Grounding

All equipment must be connected to a good ground—preferably to a long metal rod driven into the earth (which is why it is called a "ground"). There is probably a ground rod near where the power comes into your house; the electrical boxes will be connected to that rod through the ground or neutral wire in the house wiring. Connecting the case of radio equipment to a ground reduces the possibility of electrical shock should a piece of equipment fail and the radio chassis or cabinet becomes connected to the power line or some high-voltage source in the radio—that is, it becomes electrically "hot."

If connected properly, three-wire power cables plugged into three-wire grounded power outlets, or two-wire plugs with one larger pin plugged into polarized outlets, will connect the chassis to ground through your house wiring. But most amateur radio operators prefer to drive a separate ground rod close by, just for their station. A ground system to prevent shock is generally referred to as "DC ground."

Another feature of the grounding system is to provide a path to ground for any stray radio-frequency (RF) current inside the station. Stray RF can cause equipment to malfunction. Also, a good RF ground is important to make the whole station work at its best; the ground provides the "return path" for the radio waves you are sending out.

Antennas may be hit by lightning and you must provide a path to ground for the energy from lightning strikes. Ground antenna feed lines to safely bleed off static buildup during electrical storms. Many operators put *lightning protectors* in their feed lines where the lines enter the house. These devices provide a safe path for static to discharge to ground, even if the feed line is still connected to the radio.

Nothing can protect your radio against a direct lightning hit, or even a nearby strike. During stormy weather, unplug radio equipment from power outlets and disconnect the antenna feed line at the back of the radio.



## Building Project

Here is your chance to put your knowledge about electrical components, currents, and circuits to practical use. Plus, you will get a souvenir for your effort. Once you complete this project, you can try more challenging projects.

### Make a Crystal Radio\*

Radios might seem super high-tech. But with about \$10 and one afternoon, you can make one at home. Your AM creation—also called a crystal radio—will operate the same basic way radios did in the late 1800s. A crystal radio is a simple receiver. It needs no battery or power source other than the energy of radio waves received by the antenna wire.

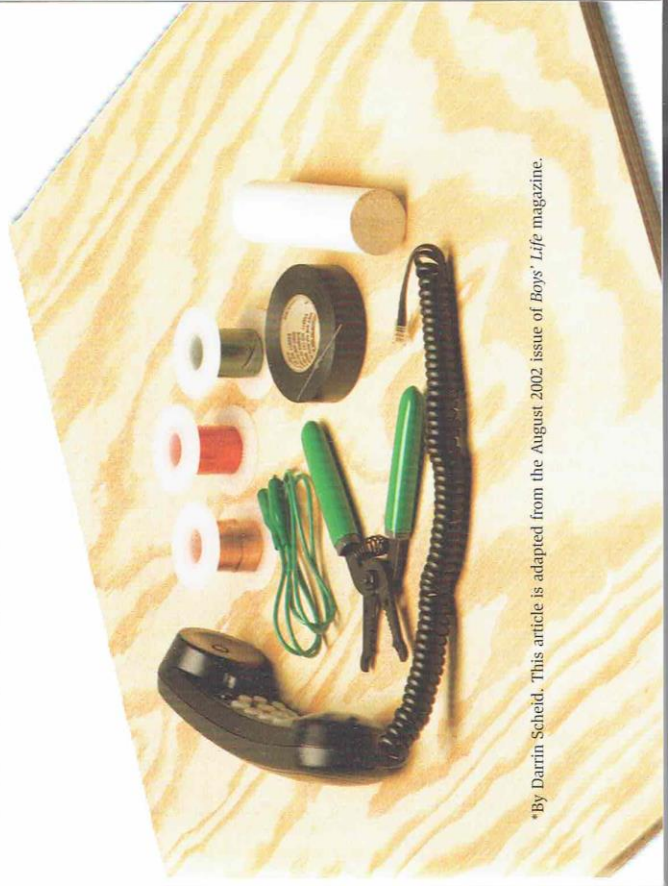
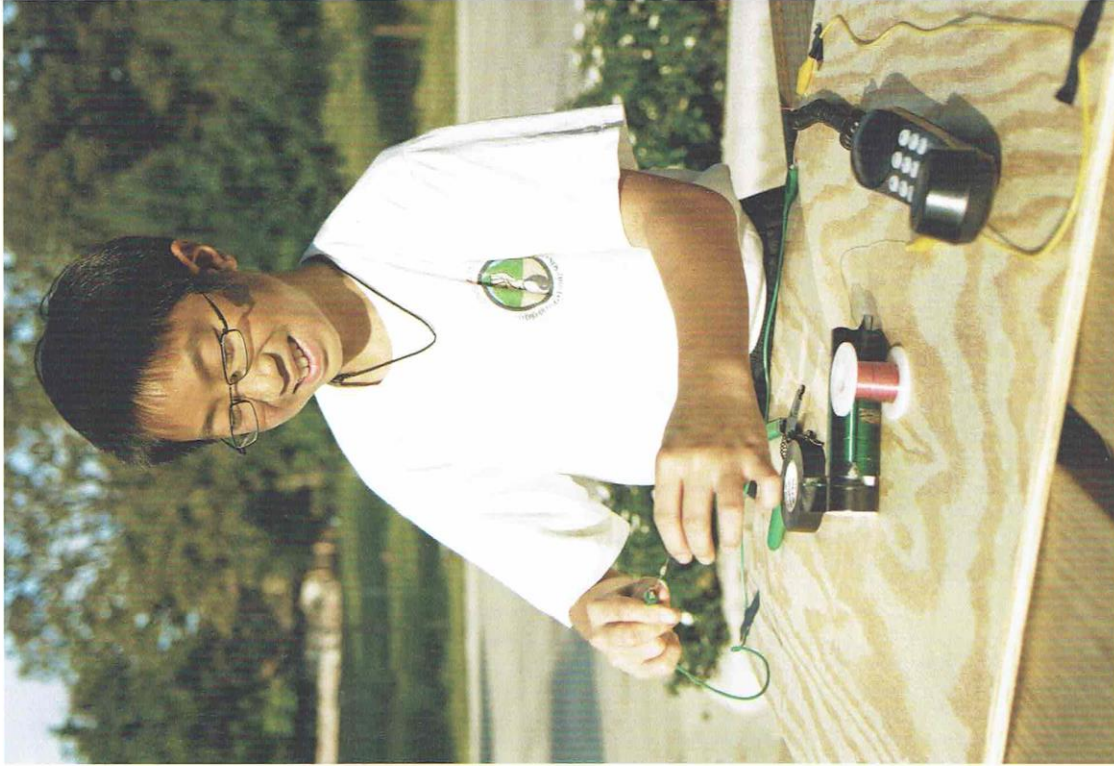

\*By Darrin Scheid. This article is adapted from the August 2002 issue of *Boys' Life* magazine.



### What You'll Need

- **Magnet wire.** Electronics supply stores sell a set, for about \$4, that comes with 40 feet of 22-gauge, 75 feet of 26-gauge, and 200 feet of 30-gauge magnet wire.
- **1 set of alligator leads** with clips at each end.
- **1 diode.** Look for IN34A diodes, also called "germanium diodes," at an electronics supply store.
- **1 insulated tube** about 1 inch in diameter and 6 inches long. It can be a toilet paper or paper towel roll, a piece of wood, or even a glue stick, as long as it isn't metal. It doesn't have to be perfectly round, but using something round is easier for winding.
- **Electrical tape.**
- **Wire stripping pliers.**
- **Telephone handset with cord.** If you don't have an old phone that you don't use anymore, you will need to buy a telephone cord, then borrow the handset from a phone to make the radio work. (Get your parent's permission first.)
- **One board** for mounting your radio—2 feet by 2 feet will work. You can make the radio without this, but having a workspace and a place to mount the radio makes it easier to carry around while you're looking for a place to hook the ground wire.

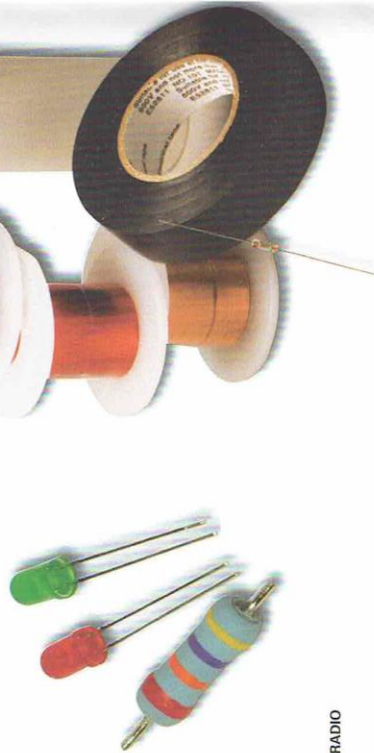

### What You'll Do

- Step 1**—Wind 26-gauge wire (the green magnet wire) around the insulated tube until it covers nearly the entire cylinder. Keep the wire tight. Leave about 6 inches of wire on each end. Once you are finished winding it, tape around both ends of the cylinder to make sure the wire holds. Then mount the coil to the board with electrical tape.
- Step 2**—Strip the ends of the wire you have left from each end of the coil. Use wire stripping pliers or sandpaper to remove the enamel or coating and expose about 1 inch of wire.

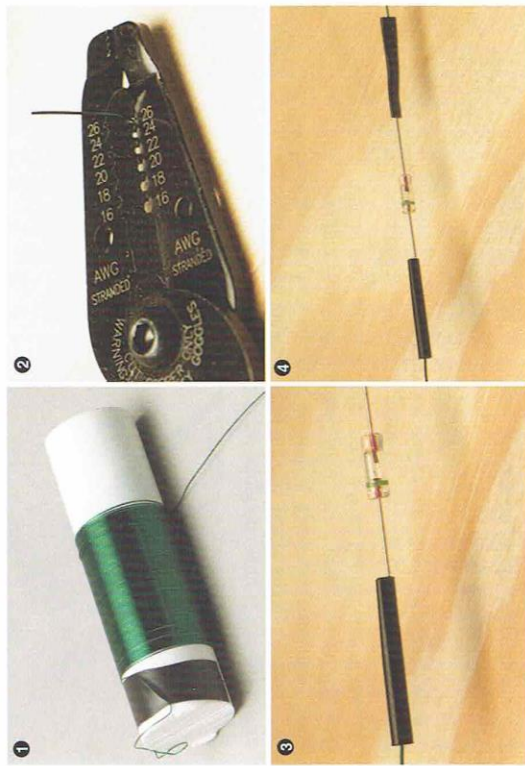

**Step 3**—Attach the wire from the right side of the coil to one end of your diode. Tape the connection.

**Step 4**—Cut the end of the phone cord and strip about 2 inches of it. Removing the outer insulation should expose two wires. Strip those wires. This wire is thin; take your time and work carefully. (Tip: Before hooking up the tiny telephone cord wires, get some thicker insulated magnet wire and tape about 2 inches to each wire. This will make the rest of the task easier.) Attach one end of the wire to the exposed end of the diode. Tape that connection.



If your phone cord has four wires inside instead of two, you must figure out which two will work. Place one wire against the positive (+) pole of a 9-volt battery and another wire on the battery's negative (-) pole. When you find a combination that makes a clicking sound in the handset, you have found the two wires to use.

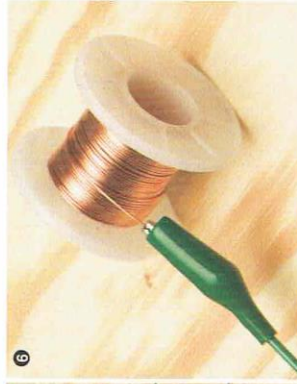

**Step 5**—Connect the second telephone wire to the green wire coming from the left side of the coil. Before taping this connection, clip one of the alligator leads to it. Then tape those three wires together—the alligator lead (that's your ground wire), the telephone wire, and the wire coming from the left side of the coil.

**Step 6**—Make your antenna by clipping one of the remaining alligator lead wires to one end of the 22-gauge magnet wire. Leave this wire on its roll.

**Step 7**—Scrape a thin strip of enamel from the wire wrapped around the insulated tube. You can do this with any sharp object or a piece of sandpaper.

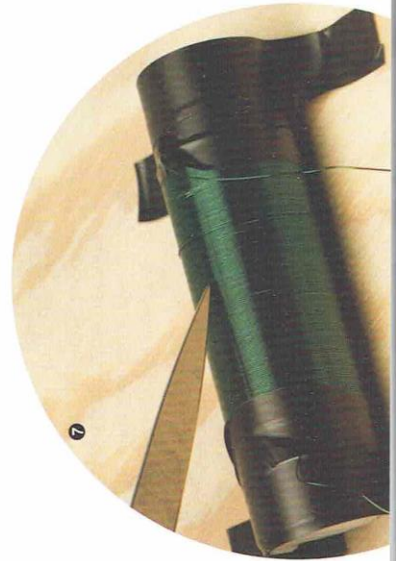

### See If It Works

**Step 1**—Attach your telephone cord to the handset.

**Step 2**—Find a good ground for the alligator wire that's connected to the left side of your coil. A pipe going into the ground is perfect.

**Step 3**—Unroll the antenna wire and hang it over a tree branch with help from an adult.

**Step 4**—Touch the alligator clip that leads to your antenna wire to the top of the coil. You should be able to hear an AM radio signal.

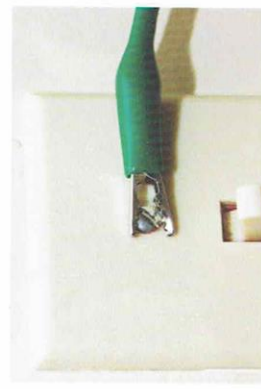

### Troubleshooting

If you can't get any signal, reattach your ground wire. With permission from an adult, loosen one screw that holds the faceplate to a light switch or outlet. Unscrew it just enough to hook your alligator clip. Don't remove the plate.

If you get a weak signal, the problem is with your antenna. If your parents have an old television antenna, hook your radio antenna wire to one of the connections on the TV antenna wire instead of running wire up a tree.



## Amateur Radio

“... WB2JWD DE K2BSA/4—OK MIKE TNX FER CALL—QTH IS THE 2005 NATIONAL SCOUT JAMBOREE, FORT AP HILL, VIRGINIA...”

“WA2EOW this is 4Z4HS—four zed four happy Scouts—the Sea Scout club in Tel Aviv, Israel—nice to talk to you in the Jamboree-on-the-Air, Doug...”

“This is VE0MCM... we’ve been adrift in high seas for three days... location unknown...”  
 “... KC4US, we’re in Little America, Antarctica...”

Amateur “ham” radio is a gateway to the world for millions of people around the globe. During the 10 days of the 2013 National Scout Jamboree, Scouts at amateur radio station K2BSA made 1,958 contacts with people across the country and worldwide, including an astronaut aboard the International Space Station. Counselors onsite taught Radio merit badge classes, resulting in 339 Scouts earning the badge. At previous jamborees, K2BSA contacted the space shuttle and the Russian space station *Mir*.



Scouts who take part in Jamboree-on-the-Air, or JOTA, receive a special patch.

Each October, Boy Scouts, Girl Scouts, and Scouters on every continent get together for a Jamboree-on-the-Air. What is JOTA? It's one weekend when any Scout can find a ham radio operator and get on the air to talk to other Scouts who are operating on the air with a ham radio operator. You might talk to Scouts in Africa, Europe, and South America.

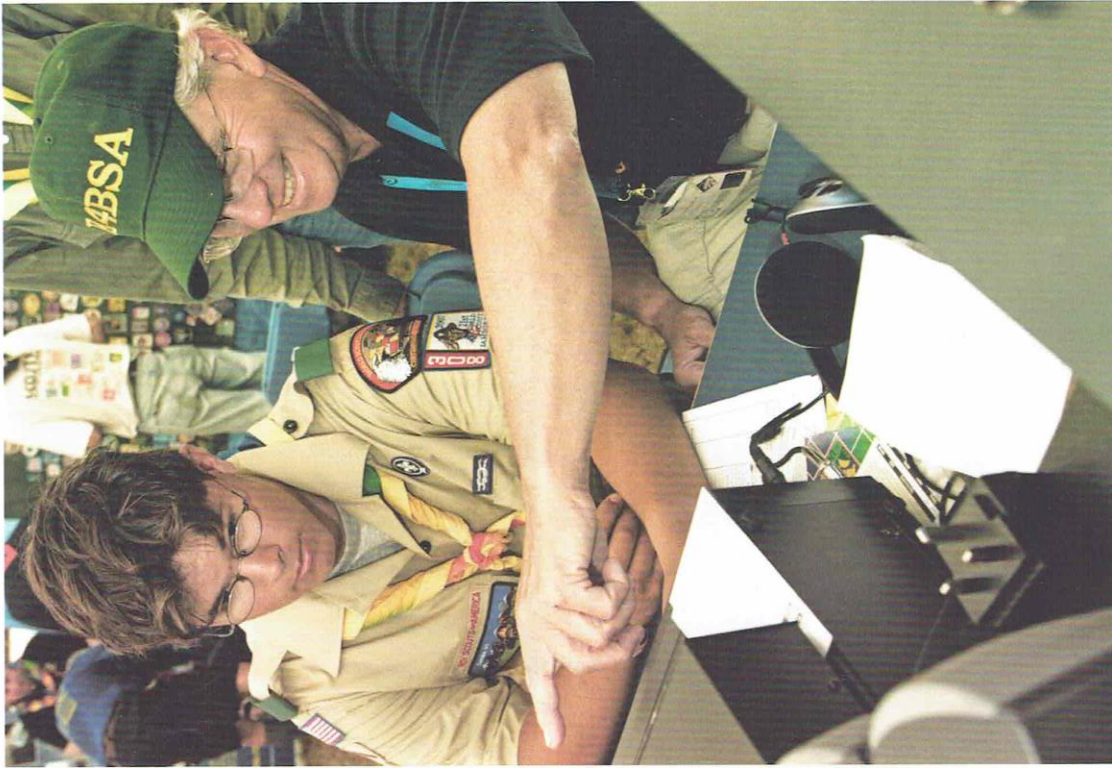



Ham radio isn't only for fun. Hams everywhere practice the Scout motto, "Be Prepared." Hams regularly prepare for disasters by setting up mock emergencies, which they call Stimulated Emergency Tests. During earthquakes, tornadoes, and floods, amateur radio operators have been the only lifeline for emergency messages. Hams also provide public service communications for events like parades, foot races, and bike rallies.



During emergencies, ham radio operators handle messages for disaster relief agencies like the American Red Cross.

### What Else Can You Do?

The sky is the limit in ham radio. Hams have built more than a dozen satellites—the only space vehicles ever built that can be used by anyone from any country, free of charge. As a ham, you can talk to other hams via Morse code, voice, or television. You can hook up your home computer and let it "talk" to other computer enthusiasts over the radio through *packet radio*, or use the computer's sound card to send and receive pictures through *slow-scan television* (SSTV).

The first award you might get as an amateur radio operator may be the Rag Chewers' Club certificate.



You can talk to people in Antarctica or to someone next door. If you talk to someone for a half-hour, you can earn the Rag Chewers' Club certificate. You can earn an award for talking to a ham on each of six continents: North America, South America, Asia, Europe, Africa, and Oceania (which includes Australia and Antarctica). If that is too easy, there is an award for talking to hams in every state or in a hundred countries.

Field Day is a test of how well ham radio operators can set up in times of emergencies. You can take part in a Field Day contest and see how many other hams you can talk to in a weekend while operating in a tent, without using power from the electric company.

There is nothing like throwing a wire antenna over a tree branch and hooking it up to your radios to talk around the world on a summer afternoon in Scout camp, or during long winter evenings, camping with the troop.

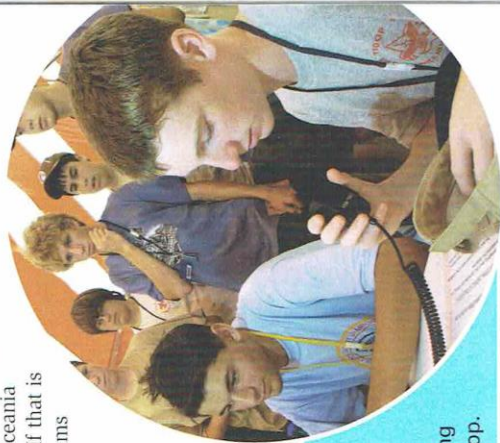

Hams come from all walks of life. The voice at the other end could belong to a U.S. senator, an astronaut, or a eighth-grader. The ham you hear could be hiking in the mountains or sitting in a wheelchair. The Morse code coming from your receiver might be from a retired ship's radio operator, or from the nervous hand of a Scout making his first contact. It's all first names on the air, so you will never know unless you ask.

Why does the government allow amateur radio operators to talk on so many different radio frequencies? Ham radio operators have always assisted in times of emergency or provided community service. The FCC's purpose for allowing hams to take part in the hobby is to increase the number of electronics experts, to improve goodwill with other countries, to assist with emergency communications, and to experiment with radio and communications.



### What's With the Funny Nickname?

Why are amateur radio operators called “hams”? There are a number of explanations, but the most likely, according to the American Radio Relay League, is this: In the old days of land-line (wired) telegraphy, a poor operator was called a “ham”—perhaps because it sounded like he was pounding on the key with a ham instead of his fingers. When radio started in the early 20th century, the only trained telegraph operators available worked for the landline telegraph companies, so they were the ones hired to handle the radios in ships and coastal stations.

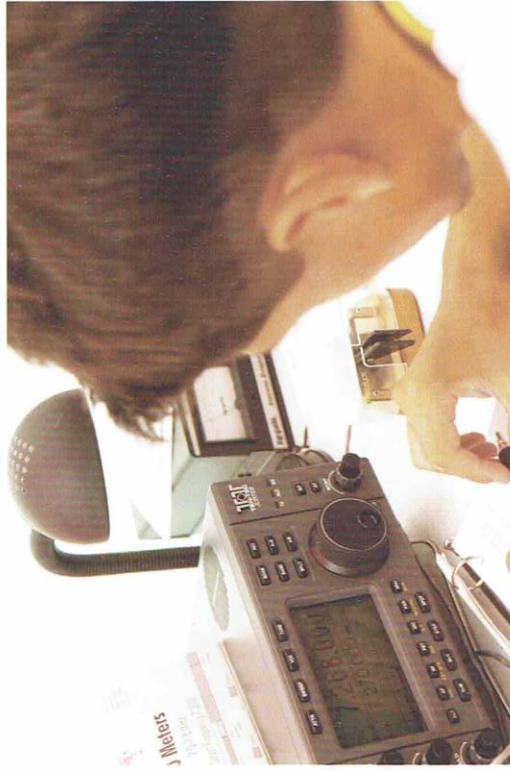

In those early days, every transmitter used the whole spectrum with a broad spark signal: basically, they all transmitted static. Two amateurs communicating with each other across town could effectively jam all the other operations in the area. The ship-to-shore operators complained to one another about interference from amateurs and would call them by the insulting name “hams.” The amateurs, hearing this, and possibly not knowing the real meaning of the word, said: “That’s it—we’re hams!”

The name stuck. Since then, the original meaning has been forgotten, and “ham” has come to mean “amateur radio operator.”

### Shortcuts and Q Signals

Over the years that hams have been using Morse code, they have developed a sort of “radio language.” Some of it is borrowed from the other radio services many early hams started in or listened to, like the military, ship-to-shore, railroad, or telegraph services. Most “Q” signals, for example, were adopted by international treaty for use in the ship-to-shore service so that ships from any nation could communicate with any other ship or shore station, regardless of what language the operator spoke. Other parts were developed by hams. Wherever the radio language came from, its purpose is for easy communications between hams who might not speak the other’s language.

The first part of radio language is the special signals that divide up radio messages and indicate intentions. (A bar over the letters means they are sent as a single character run together, not as two distinct characters.)

The most common radio signals are:

**CQ**—“Calling any radio amateur”  
**DE**—“From” (“WB2JWD DE K2BSA,” for example)  
**BT**—(a break in the text)  
**AR**—End of message  
**K**—“Over” (any station is invited to transmit)  
**R**—“OK” (transmission received in full)  
**SK**—“Out” (end of contact)

Next are Q signals. While Q signals are most common in Morse code and digital (“teletype”) operations, you will hear some of them on voice as well. These are three-letter combinations starting with the letter Q. Each is a message in itself, with two meanings—one with a question mark following, one without. For example, “QTH?” means “What is your location?” while “QTH” means “My location is . . .”

There are many more Q signals than are normally used by hams, but most of these deal with situations that rarely arise (“QTO?” means “Have you left port?”). Some Q signals have developed a different meaning in ham radio usage than in the international treaty. For example, “QRP” means “Please reduce your power” in the international definition, but to a U.S. ham operator it means “low power operation.”



The most useful Q signals are:

**QRIM?**—"Is my radio signal being interfered with by man-made noise?"

**QRIM**—Interference. ("Your radio signal is being interfered with.")

**QRN?**—"Is my radio signal being interfered with by atmospheric noise, static?"

**QRN**—Static. ("Your radio signal is being interfered with by static.")

**QRP**—Low power radio operation.

**QRS**—"Send your Morse code more slowly."

**QRT**—Leaving the air. ("I'm stopping my radio activity.")

**QRX**—"Wait a few minutes."

**QSB**—"Your signals are fading."

**QSL**—A card sent to indicate you've talked to or heard a radio station; also, as a Q signal that means "Received OK."

**QSO**—A conversation.

**QSY**—"I am moving to another radio frequency. . . ."

**QTH?**—"What is your location?"

**QTH**—"My location is . . ."

And, two unofficial Q signals:

**QST**—"Calling all radio amateurs for a bulletin."

**QLF**—"Try sending Morse code with your *left* foot now." (Sent as a joke to indicate that the other operator's transmissions are hard to understand.)

Finally, here are abbreviations that have been invented by hams and other Morse code users over the years. Most hams use these to save time.

**ABT**—About.

**AGN**—Again.



**BCNU**—Be seeing you.

**BK**—Break, back (BK 2 U).

**CPY**—Copy (receive).

**CUAGN**—See you again.

**CUL**—See you later.

**CW**—Morse code.

**DX**—Long distance, foreign stations.

**FB**—Fine business (excellent).

**GE**—Good evening.

**GL**—Good luck.

**HI**—(A) laugh; several usually are sent.)

**HR**—Here; hear.

**HV**—Have.

**HW**—How.

**OM**—"Old man." (Male radio operator)

**PSE**—Please.

**RPT**—Repeat.

**SIG**—Signal.

**TNX**—Thanks.

**U**—You.

**UR**—Your.

**VY**—Very.

**WX**—Weather.

**YL**—Young lady.

**73**—"Best regards."

**88**—"Love and kisses."

**RST**—Readability Strength Tone (signal rating; 599 equals a perfect radio signal).





Try to decode this typical Morse code or teletype radio contact or QSO between two ham operators.

CQ CQ CQ DE K2BSA K2BSA K2BSA K

K2BSA DE WB2JWD WB2JWD AR

WB2JWD DE K2BSA BT TNX FOR CALL OM BT NAME IS LEE BT QTH BOY SCOUT JAMBOREE, FORT AP HILL, VA BT UR SIG RST 599 BT BK 2 U HW CPY OM? K

K2BSA DE WB2JWD WB2JWD R FB LEE GE 2 U BT NAME IS MIKE BT QTH HARFORD, NY BT UR SIG 589 QSB BT QRS PSE? TNX K

WB2JWD DE K2BSA OK MIKE BT WX HR SUNNY AND HOT BT GOT 2 RUN CHOW TIME BT 73 AND CUAGN K

K2BSA DE WB2JWD R FB OM 73 GL BT PSE QSL BT BCNU R K2BSA DE WB2JWD SK

### QSL Cards

After a radio contact, ham radio operators like to send the other ham a QSL card confirming the conversation. A ham writes on a QSL card the information from the radio contact, information that is kept in a logbook. (A logbook is where hams record—log—their radio contacts and keep notes on the interesting things they talked about.)



QSL cards are exchanged to confirm radio contacts between stations. Some cards have photos or drawings.

QSL cards vary from simple postcards to multicolor certificates nice for framing. Many hams have their QSL cards printed commercially, but many others make up their own. The thing all QSLs have in common is the information to properly confirm the contact:

- Your call sign and the other station's call sign
- The time, date, and radio frequency band of the contact
- The mode (Morse code, voice, packet)
- A radio signal report (RST)

DATE	FREQ.	MODE/POWER	TIME	STATION WORKED	REPORT SENT/REC'D	TIME OFF	QTH	COMMENTS NAME	QSL VIA	STR
16 NOV	3715	A1A 100	1800	KATEBY	599 479	1835	MANOMET, MA	JOHN WILLIAMS	✓	✓
			1840	WB2JWD	599 589	1955	TUFTS UNIVERSITY	DAVE GOES TO DENTAL SCHOOL		
17 NOV	28.025	A1A 100	2000	VF2ML	579 589	2003	CARIBBEAN	GOD—NICE WR BIG PILE UP	✓	✓
23 NOV	28.140		2010	K4PHJD	599 589	2015	DES MOINES, IA	KRISTEN AND DAD, W8PH	✓	✓
				W8SH				THEY COLLECT OLD TELEGRAPH KEYS!		
	3770	A1A 100	2033	K1G6QJ	579 589	2055	LINDA	NURSE IN A HOSPITAL	✓	✓
20 NOV	3715	A1A 100	1645	NAIL	559 569	1700	DALE IS A LAWYER, GOOD SIGNAL		✓	✓
							KARL, KY—CHERYL			
	5772	A1A 100	1702	A4Z2	589 589	1705	EAST HAMPTON, CT	WOW!	✓	✓
							MARK WORKS AT ARRL HQ!			
	3720	A1A 100	2315	WATBY		2325	HENRY—OM QTC 2			
	21175	A1A 100	2332	N6TK	539 569	2345	OREGON	SAID HIS NAME WAS "TREET"	✓	✓

Your amateur radio logbook might look like this. Your entries can include date, frequency, time, call signs, signal reports, and notes about the radio contact.

Even before you get your license, you can send signal reports to hams you hear and request a QSL in return. You can look up a ham's name and address on the Internet (with your parent's permission). Many ham operators buy printed callbooks or CD-ROMs every few years—you might be able to pick up an older copy for free by asking around.

With your parent's permission, you can look up a call sign on the American Radio Relay League's website at [www.arrl.org/fcc/search](http://www.arrl.org/fcc/search).



## The Licensing Ladder

You can become a ham radio operator. There is no age limit. The youngest ham in the United States got his first license when he was 5 years old. You can do it, too.

### Technician: The Tenderfoot of Ham Radio

Your Technician Class license is the first ham radio "ticket" to earn. It will be your passport to adventure on the airwaves. Technician Class radio operators may sample just about everything ham radio has to offer—from satellite communications and computerized packet radio to "chasing DX" (hunting for stations in exotic countries). Technicians may use any mode to communicate on the amateur radio bands above 50 MHz (6 meters). This includes the very popular 144 to 148 MHz (2-meter) and 420 to 450 MHz (70-centimeter) bands, where repeaters can extend the range of a low-powered handheld radio to 50 miles or more. These bands are great places to meet local hams who can introduce you to the never-ending variety of ham radio—and help you work toward a higher-class license.

As of March 2007, you no longer need to learn the Morse code for any class of amateur radio license. Morse code has been eliminated as a requirement for ham radio licenses.

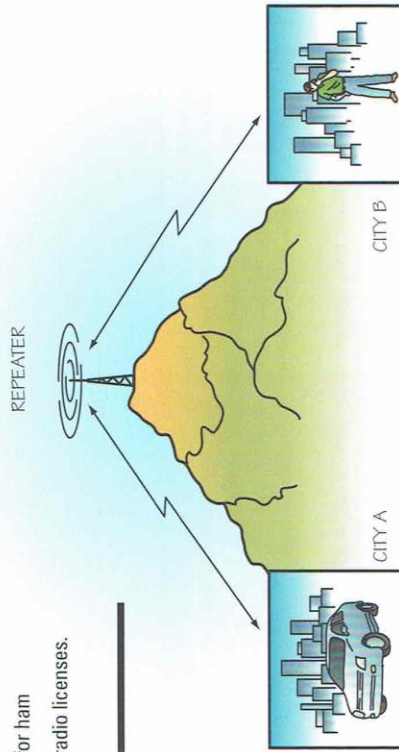

You can use a handheld radio while walking or driving to send your signal through a repeater. By using repeaters, you can talk to people farther away.

As a Technician Class operator, in addition to the VHF and UHF bands above 50 MHz, you may also use frequencies on the 10-meter HF band between 28.3 and 28.5 MHz to talk with people all over the world. You can use Morse code on four other HF frequency bands to make contacts up to a few hundred miles away on the 80- and 40-meter radio frequency bands, and up to several thousand miles away on the 15- and 10-meter radio frequency bands.

The 70-centimeter (cm) and 1.2-gigahertz (GHz) frequency bands include a couple of amateur TV channels (yes, you can send your own TV signals) and the chance to be a part of some of ham radio's newest developments. (What are they? We don't know—they haven't happened yet!)

Once you earn the Radio merit badge, you will know almost enough to become a Technician Class ham radio operator. All it takes is a multiple-choice written exam, which you can take at a volunteer exam session through a local ham radio club or at a get-together of ham operators ("Hamfest") in your area. The test consists of 35 questions on basic regulations, operating practices, and electronics theory, with a focus on VHF and UHF applications. This license gives you full amateur privileges, including permission to transmit on repeaters on the popular 2-meter band.

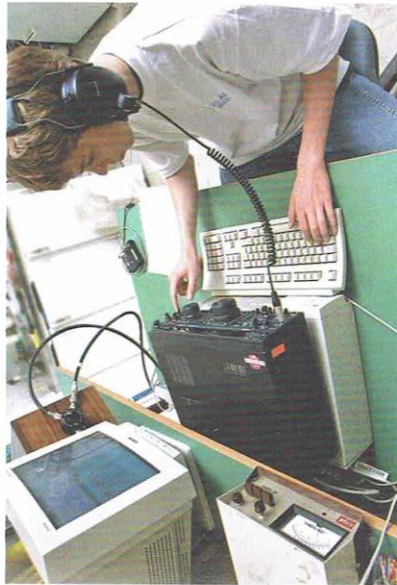



### Higher License Classes

The Technician license is the first step on the ham radio license ladder. Each higher class of license is a little harder to earn, but each presents new privileges and opportunities.

**Step 2: General Class license.** To get your General Class license—a giant step up in operating privileges—you will take another 35-question written test. This test covers intermediate regulations, operating practices, and electronics theory, with a focus on HF applications. With your General Class license under your belt, you can operate on at least part of every amateur radio band from HF through microwaves, in every permitted transmission mode, at the full permitted power level. The high-power HF privileges granted to General licensees allow for cross-country and worldwide communication.



Some people prefer to earn the General Class license as their first ticket, so they may operate on HF right away.

For more information, contact the American Radio Relay League (see the resources section at the end of this pamphlet). The ARRL has many useful materials and can also put you in touch with a local club or instructor to help you.



### Be Prepared for an Emergency

We all hope never to have a real emergency, but just like Scouts, hams want to be prepared for emergency communications. In fact, one of the most popular activities in ham radio is public service through the Amateur Radio Emergency Service. ARES teams prepare for real emergencies by helping out with communications at canoe races, providing extra “eyes” for law enforcement during large public events, and through simulated emergency drills.

On Morse code or digital modes, the standard emergency call is, as you might have guessed, SOS. No, “SOS” does *not* stand for “Save Our Ship,” or for anything at all. It was chosen because this simple sequence of three short, three long, and three short (dididit–dahdahdah–dididit) characters was easy to remember and recognize.

Because such a wide range of frequencies is available, and you cannot count on anyone listening on any one frequency, it is often necessary to repeat the emergency call a few times to get the attention of anyone tuning by. An amateur using Morse code in an emergency might send, “SOS SOS SOS DE WB2JWD WB2JWD K.” pause for a reply, then repeat until you get an answer.

On HF voice, the traditional ham emergency call is “CQ Emergency,” or you can use the international distress call “Mayday” (which comes from the French *m’aider*, meaning “help me”). As with Morse code, you cannot count on anyone listening just as you start transmitting, so you would repeat the emergency call three times, then identify your station: “CQ Emergency CQ Emergency CQ Emergency, this is WB2JWD Whiskey Bravo Two Juliet Whiskey Delta . . .” Then pause for a reply and repeat.





In VHF repeater operation, where everyone listening to the repeater can hear you, it isn't necessary to send long calls. Simply say what you mean: "This is WB2JWD, I have an emergency—can anyone help?" Some repeaters encourage the use of "Break Break" to interrupt a conversation in an emergency; on others, you just say "Emergency" and your call sign.

**However you send the emergency call, before you send it you need to think about what you will say when you are answered. What information will you need to give so you can get help?**

- Remember "WWW"—What/Where/Who:
- What is the emergency?
- Where is the emergency?
- Who needs help, and what kind?

### Autopatch Operation

If you are using a repeater that has an emergency telephone connection (*autopatch*), you can usually just dial 9-1-1 on the keypad of your transceiver and be connected directly to an emergency call center. If you are making a 9-1-1 call through a repeater, remember several things. First, make sure the operator knows that you are using a radio, so they don't try to talk over you and hang up when they can't interrupt. Say: "I'm a ham radio operator using a phone patch. I cannot hear you while I'm talking, OK?"

Then, be sure you are connected to the right 9-1-1 center. Wherever you are, the call will be routed to the 9-1-1 center for the *repeater's* phone—and the repeater might be on a mountaintop in another county many miles from where you are. Be sure to give your location immediately to the operator—"I have an emergency on Route 38 in Harford, New York, Cortland County"—so if you do not have the right center you can be transferred quickly.

Finally, since autopatch operation is nearly always one-way (you can call 9-1-1, but they can't call you), it would help if you could line up another ham on the frequency before you call, and have that person give the 9-1-1 operator his or her number for a callback.

## Radios and Antennas

Most hams have a handheld radio operating on the VHF 2-meter or UHF 70-centimeter bands. Such a radio is often called an "HT" after Motorola's trademark Handie-Talkie®. HTs are convenient to carry around, or they can be clipped to your belt or put in a cell phone-type holster. If you have an HT on your belt, it is helpful to have a combined speaker and microphone (speaker-mike) that you can clip to your collar so you can listen and talk without removing the HT from its place.

**Take a spare battery pack using replaceable AA or AAA cells if you will be using your HT for an extended period—say a week at Scout camp—or in a real emergency when power to recharge the battery might not be available.**

**Note:** Get your parent's permission before you start

drilling holes in the floor or putting things on the roof. You have been warned!

Other hams also have a radio they keep in their house, usually called a *base station*. Base transceivers today are small enough to fit on a desk or table, and the antenna is outside—often mounted on the roof or chimney, or on its own tower. Wire dipole or long-wire antennas can be strung from the roof or chimney to a convenient tree. The antenna feed lines can be led in through a window, or perhaps into a basement and then up through the floor into the "ham shack."

If outside antennas are not an option, they can sometimes be mounted inside the attic. Smaller VHF antennas can be taped to a window or along a wall.

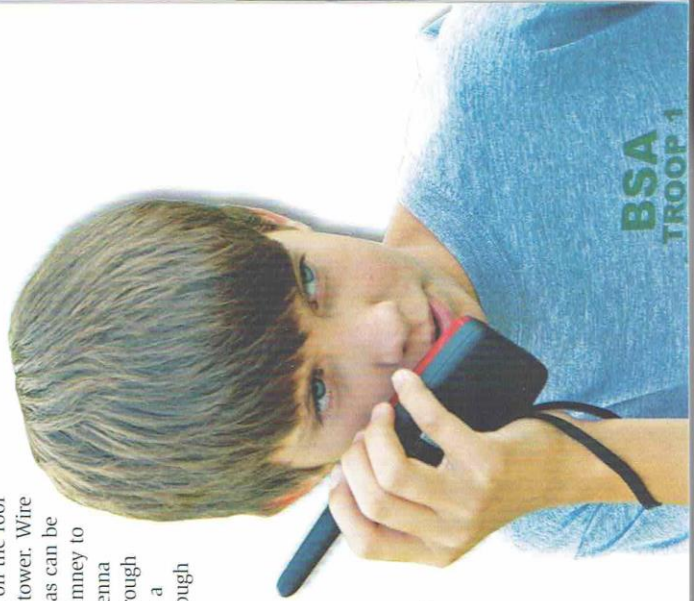



A radio that you would carry in your car could be either a handheld model or a mobile radio that can be mounted under the dashboard of a car. If you can drill holes in the car (never without permission), it is best to mount the antenna in the center of the roof or trunk lid, with the feed line run inside the headliner or under the carpet. If that is not possible, magnetic mounts are available, so that the antenna can be stuck to the roof or trunk lid and the feed line fed through a window or the trunk. A handheld radio will not work as well in a car as it will outside (the car will interfere with sending and receiving signals), unless it can be connected to an exterior antenna.

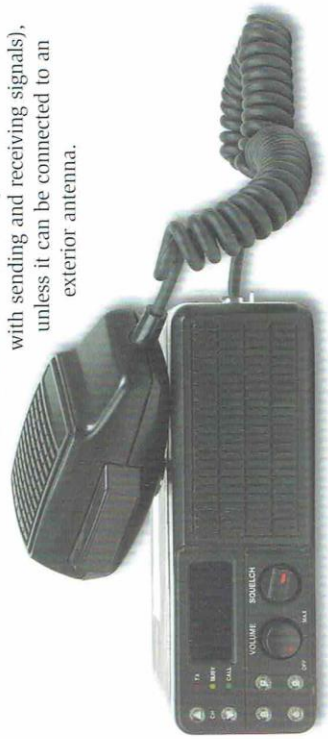

### U.S. Amateur Radio Frequencies and Bands

The chart on the next page shows the most commonly used ham radio frequencies and bands. The ranges listed will give you some idea of what to expect. They vary tremendously depending, for the most part, upon sunspot activity. During periods of high sunspot activity, you can get 24-hour worldwide operation on the 10-, 15-, 20-, and 40-meter frequency bands. During periods of low sunspot activity, you may find 10 and 15 meters to be useless even during the day.

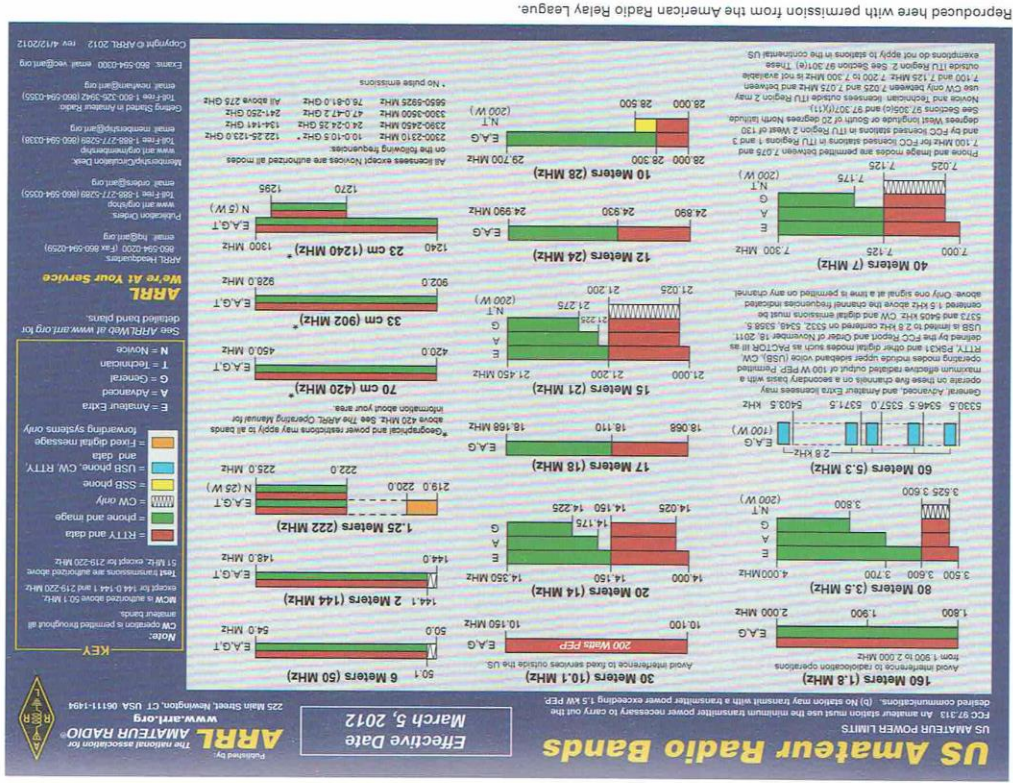





## Broadcast Radio

Radio broadcasting is a part of everyday life. We get up to the sound of clock radios and listen to background music from radio receivers during the day in our cars and homes. We in the United States enjoy the widest variety of broadcasting available anywhere in the world. No matter what you like, there is a radio station to listen to, somewhere.

Radio broadcasting can be commercial (money-making) or noncommercial. Commercial stations, as the name implies, support themselves by the sale of advertising ("commercials"). Noncommercial stations support themselves with fundraisers, government grants, endowments, and financial contributions from businesses, organizations, and individuals.

Commercial stations are businesses with paid employees, but noncommercial stations can also have employees. Some noncommercial stations, like those at colleges and universities, operate with all-volunteer staff made up of students. Public radio stations, like NPR (National Public Radio) or PRI (Public Radio International), or religious broadcasting stations often have both employees and volunteers.



### Radio Station Program Formats

Every radio station has its own distinctive "sound," or format. As you think about the schedule for your imaginary station with the call letters KBSA, you will have to decide what format to follow. The main purpose of a radio station is to get and hold an audience, and the audience will listen to your station only if they know what to expect and like what they hear. Most of the time, this means that all of the programming on your station should have a certain sound.

What kind of sound? Radio programmers have come up with names for certain types of station formats. Here is a look at the more common formats.



**Rock stations** come in many forms. Top 40 or “contemporary hit radio” (CHR) stations mainly play popular or hit records. Originally, the name “Top 40” referred to the fact that an announcer or *air personality* (the old term was *disc jockey* or DJ) could choose only from a list of 40 hit single records or pop songs to play during a three-hour program. Top 40 stations appeal to a relatively young audience. Some have air personalities who move at a tremendous pace, speaking quickly and loudly. They usually air many *station promotion announcements* (SPAs or promos) and short, singing *station identifications* (station IDs as jingles).

Rock formats other than Top 40 have evolved into

**Metal**—Heavy metal, very hard rock

**Urban**—Light hip-hop, R & B (rhythm and blues), etc.

**Hip-hop**—“New School” rap, some urban crossover

**Classic rock**—Older hard rock and classics from the 1970s and ‘80s

**Oldies**—Music from the 1960s, ‘70s, and ‘80s

**Rhythmic**—Dance music, some urban and hip-hop cross-over

**Progressive**—Alternative, seldom heard or promoted by other rock formats



Personalities from some stations are allowed to build their own programs from an approved list of artists and groups that fit the station’s format. For other air personalities, the station provides a list of what music is to be played at what time.

**Nostalgia format stations** play music from the late 1940s through today, if the style is light and sentimental. These stations appeal to an older audience than do rock stations. They may play adult contemporary music and soft rock, in a mix of old favorite pop songs, rock and roll, and current releases.

Many stations in all formats are *automated* at least during part of the day. That is, they don’t have live air personalities. Instead, air personalities record the voice parts earlier in the day or week, and an automation system inserts those voice tracks (VTs) into the hourly mix at the right time. The system makes the programming sound like the air personality is really there. The programs used in automation are almost always recorded onto a computer. The music arrives at the station on special CDs, on a satellite feed, or is downloaded off of radio music websites specifically for radio stations.

**Classical and jazz stations** are concentrated mostly in cities with large populations.

**Country music** is an increasingly popular format in many parts of the United States.

**News or talk radio stations** broadcast all talk with no music, up to 24 hours a day. “All news” stations are located mainly in big cities. The news may repeat hourly, or more often. (One station advertises: “Give us 20 minutes and we’ll give you the world.”) Sometimes features are scheduled

multiple times each hour—“traffic on the three,” for example, where traffic reports are given at 11:03, 11:13, 11:23, and so on.

The “talk radio” format became popular in the late 1980s and remains the primary format on the AM airwaves in many markets. Talk radio stations broadcast programs featuring air personalities, guests, and calls from listeners. A given personality might have a particular political slant, or present medical or legal advice, or help callers with problems with their lives, gardens, or cars.

Most stations in all formats run news at times during the day, most often on the hour or half hour. Radio news services, such as the Associated Press, provide national news to stations without news departments of their own.

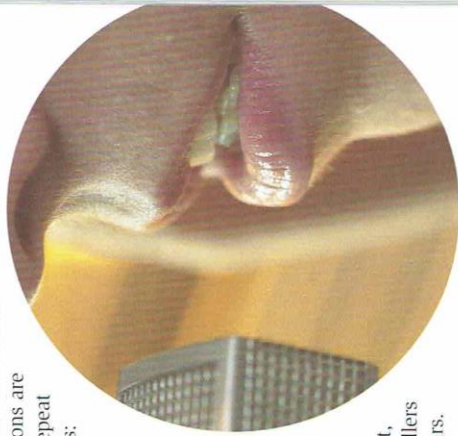



Most talk programs are *syndicated*, which means the personality does the show at one location (usually one of the big markets like New York or Los Angeles), and other stations pick up the show from a satellite or Internet feed. In many cases the local stations schedule the program at a different time, rather than broadcast it live.

Some stations broadcast especially to minority groups and have **ethnic programming**, such as cultural shows in foreign languages, or music from a particular country. Some stations specialize in ethnic programming for many groups, with Spanish programs following German programs, followed by Polish programs, etc.

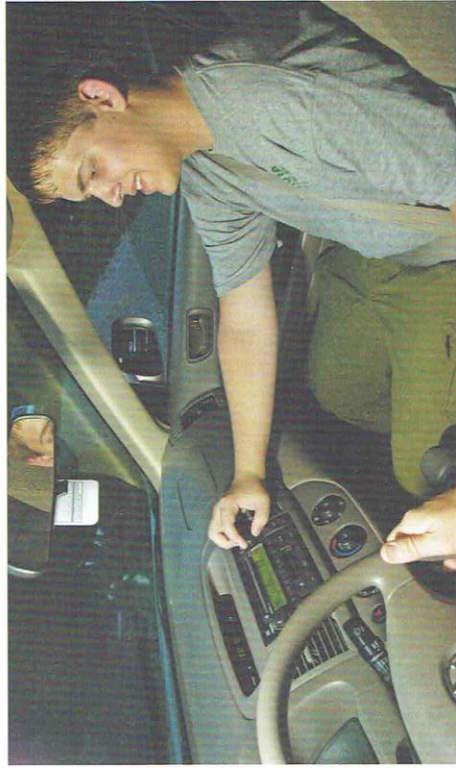

### Dividing the Day: Time Blocks

Many radio stations break the day into blocks of hours devoted to programs with different air personalities covering their assigned shifts. Peak listening time for broadcast radio is during the morning "drive time" (5:30 A.M. to 10 A.M.), as listeners get ready for the day and commute to work or school. Most listeners are busy working or studying during the midday hours (10 A.M. to 2 P.M.), but many play their radios in the background. Many stations will schedule local news with a live air personality during the morning and afternoon drive time, even if most of the rest of the day is automated.

The afternoon drive time (2 P.M. to 7 P.M.) also is a high listenership period when audiences are commuting home, doing homework, and eating supper. The evening hours (7 P.M. to midnight) find listeners relaxing and having fun. The overnight hours (midnight to 5:30 A.M.) generally attract night owls and third-shift workers.

Radio stations schedule programs for each of these periods to appeal to the expected audience for that time block. Individual programs might have names like "The J. Doe Show" or "A.M. Edition." Weekend programming usually offers specially shows in addition to formatted music. Programs may include listener-requested music, blocks of music by particular artists, live music, remote feeds from outside the station, artist interviews, public affairs programs, countdowns of top songs, and more.

Besides dividing the day into blocks of hours filled by programs, stations break down each hour into segments. Times are scheduled in the segments for various elements such as news, weather, concert and event information, commercials, announcements, and music sweeps (long sets of uninterrupted music). The schedule looks much like one you would see for a TV guide.

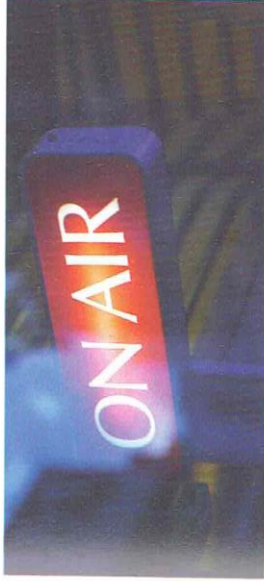

"We interrupt our program of dance music . . ."

On Halloween Eve in 1938, entertainer Orson Welles presented an on-the-air adaptation of H. G. Wells's science-fiction novel, *The War of the Worlds*, as a series of radio news bulletins. Thousands of listeners panicked because they believed they were hearing an actual Martian invasion of the United States. This *Mercury Theatre on the Air* broadcast got more attention and publicity than any show in radio history.





### Your KBSA Radio Station

Which radio format will you choose? You have to decide what audience you want KBSA to attract. For Scout-age youth, Top 40 or progressive might be best, or perhaps country music or urban might have wider appeal. Who will your air personality be? What sort of format suits your personality's personality?

**Scheduling Commercials.** Commercials are important to your station. Radio stations have only one product to sell: time. Selling time—usually 30 or 60 seconds at a time—is what pays the bills. Commercials provide money for the station and pay employee salaries. Many people who work in broadcast radio don't fully understand that they are in the business of creating an audience to hear the messages from the sponsors.

Who are your sponsors? You will want to schedule their commercials (*spots*) carefully. For instance, you wouldn't want to place competing advertisers, such as two different car manufacturers or beverage companies, next to each other during a *stop set* (a break in the music). You wouldn't want to put an ad for Mom's Pie Shop between ads for rat poison and insecticide—at least, not if you want to keep Mom's Pie Shop as a client.

Will your announcer read the commercials, or will the voiceover and production be done by an outside ad agency? Most commercials run exactly 30 seconds or 60 seconds. Be careful not to let the DJ start talking before an ad is over.

If your KBSA is a noncommercial station, you will schedule *underwriting credits* instead of commercials. Credits mention the sponsor's name, event, or service and may describe the product or service, but there can be no "call to action" in the announcement. If Rusty Auto Sales, for instance, sponsors a program on your noncommercial station, the credit can't say, "Hurry down and buy a new car today from Rusty Auto." The message would be more along the lines of "Rusty Auto Sales, purveyors of fine automobiles, new and used. More information is on the Web at . . ."

**Scheduling News.** Use some lined paper to divide a half-hour program by minutes. When will your station run its news, at the beginning or end of the period? On the quarter hour? How long will the news take?

Choose a few headlines from your local paper to make up the program's news segment. Read the headlines aloud to see how many minutes you take to get through them. You don't want to leave long gaps of silence with nothing on the air (called *dead air*). Do you want to have a special introduction (*intro*) to the news, like the ticker-tape sound effects many stations use, or a musical introduction? Or should the announcer just slide (*segue*) into the news from what was on before? Will you want to do a remote feed from outside the studio, like an on-the-street report with a late-breaking news story?



This public service announcement, or PSA, comes from the Centers for Disease Control and Prevention, Atlanta, Georgia.

*Vaccination is one of the best things you can do to protect your children. Ask your doctor or nurse if your children are up-to-date on their immunizations. For more information call 1-800-CDC-INFO or visit <http://www.cdc.gov/vaccines>. This announcement is sponsored by [add your organization here].*

PSAs can be made at the station or can come from organizations like the Advertising Council. They usually deal with some matter of interest to the public, like preventing drunk driving or getting voters to turn out at election time.

How about including a PSA for the Boy Scouts of America?

**Scheduling PSAs.** It is important that your station run public service announcements, or PSAs. While the FCC no longer requires PSAs to be run once per hour, each station must address a number of significant issues important to the community, in the form of PSAs, news stories, or special promotions. The station must report on those efforts to the FCC several times a year, to tell the FCC how the radio station is doing its "good turn" in trade for being allowed to use a broadcast license.

**Scheduling Music.** You will want to schedule the music you choose to be sure it will fit into the time you have. You can easily check the length of a song if it's on a compact disc (CD) by placing the disc into a CD player that has a readout giving the length. Lengths are listed in minutes and seconds, such as 3:29. Often the length of a song is printed on the CD itself or in the booklet that comes with the disc.

Will your DJ talk over the fading end of the music (called an "outro") or just segue (fade) smoothly from one song to the next in a sweep?

Be sure the music you choose matches your format and the other music played. You may like both classical music and hip-hop, but a quick cut from one to the other on the same program may cause listeners to tune out—especially if your format is beautiful music.

**Station Identification.** Be sure to identify your station. While the FCC requires stations to give their call letters at the top of every hour, most stations identify (ID) much more often than they legally must. You will want people just tuning in to know who you are.

You might have the DJ simply give your call letters ("This is KBSA"), or use a slogan ("KBSA is the place to be"). Some stations use their frequency as part of the ID ("93BBSA is it") or set the ID to a jingle ("Up, up, and away, KBSA"). Use your imagination.

## Coverage Areas

Many stations, especially distant AM stations, will be happy to receive reception reports from you—reports that you heard them transmitting loud and clear. To fulfill the second requirement for the Broadcast Radio option, you will log the date and time you heard the station (in its local time) and the program that was playing. Most stations will send a QSL card or an advertising sheet giving their coverage area and transmitting power. You can also look up the station location and transmitting power in a guide such as the *World Radio TV Handbook* (see the resources section in this pamphlet).

The FCC assigns each station a primary coverage area, but the station's signal may go much farther. Some AM stations, called clear-channel stations, are allowed to transmit fairly high power (50,000 watts) on channels that are not assigned to any other station in the same part of the country. (The same channel may be assigned to another clear-channel station thousands of miles away.) WCBS (New York) and KRVN (Lexington, Nebraska) share clear-channel 880. More stations are assigned regional AM channels like 910, and still more local channels like 1450 kHz.

Many stations have a small coverage area and limited power, like WLIX at 250 watts. Some AM stations are assigned directional coverage areas, sometimes at certain hours of the day. WHCU in Ithaca, New York, for example, must switch to a directional pattern beamed north at night so as not to interfere with other stations to the east and west on the same frequency.

FM stations are limited in range by the nature of the radio frequencies on which they operate. FM channels are ranked by the class of station (power and range) assigned to them. The lowest FM channels (88.1 to 91.9 MHz) are reserved for educational broadcasting, some (especially college stations) at powers as low as 10 watts.



## Broadcast Terms\*

Here are some terms used in broadcasting.

**AM (amplitude modulation).** A method of combining an audio signal with a radio carrier wave by varying the amplitude (strength) of the carrier wave. See also *FM*.

**AM broadcast band.** This band extends from 535 kHz to 1605 kHz; stations in this band use AM and are assigned frequencies every 10 kHz starting at 540 kHz.

**audio console or board.** A piece of studio equipment that allows switching between audio sources, adjusting volume levels, and routing signals for transmission or recording.

**booth.** Soundproofed room where the engineer sits. There is usually a window between the studio where the air personality is working and the booth, so that the engineer can see and signal to the personality without sounds from the booth going out over the air.

**clear channel.** An AM broadcast band frequency assigned to only one radio station in a large geographical area.

**combo, combo operator.** The combination of the announcing and operating duties, performed by one person.

**continuity.** Transitional spoken or musical elements that keep a radio program moving.

**copy.** A written script for news, spots, or announcements.

**cross-fade.** The transition between two program events, accomplished by fading down one *pot* (volume control) while fading up another.

**cue.** A signal to begin an action or to prepare for airing.

**cut.** An abrupt transition from one sound or program element to another.

**dB meter.** Sound level meter, calibrated in decibels. See also *VU meter*.

**dead air.** Complete silence on the air; unmodulated carrier; generally an undesirable situation.

**digital radio or digital audio broadcasting (DAB).** Radio transmissions in which the audio signal is sent as a stream of numbers rather than as an analog signal using AM or FM. The signal is digitally encoded, so atmospheric noise and signal strength variations do not cause static.

**Emergency Alert System (EAS), formerly Emergency Broadcast System.** A voluntary network of radio and television stations used to alert the general public to any emergency affecting the safety of people or property, and to announce information for Amber Alert lost child notifications.

\*Many of these terms were taken from the book *Skills for Radio Broadcasters* (McGraw-Hill, 1988), by Curtis R. Holsopple, with the author's permission.

**fade.** Gradual reduction of sound level from full volume to silence.

**feed.** A signal arriving at the station from somewhere else; could be a "network feed" or a "remote feed" from an air personality at a sports game or an advertiser's location.

**FM (frequency modulation).** A method of combining an audio signal with a radio carrier wave by varying the frequency of the carrier wave, keeping the power constant. See also *AM*.

**FM broadcast band.** This band extends from 88.0 MHz to 108.0 MHz. Broadcast stations in the FM band use FM transmission on frequencies allocated every 0.2 MHz, starting at 88.1 MHz.

**level.** The loudness of an audio signal. "Give me a level" means to feed program material or speak into the microphone so that the operator can determine the proper volume setting on the board.

**live.** A broadcast where the creation of the program and its transmission happen at the same time, as opposed to having been recorded earlier.

**log.** A "program log" shows the broadcast schedule and what was actually broadcast. A "transmitter operating log" shows the transmitter's performance. A "maintenance log" contains notes about tests and equipment adjustments to station equipment.

**network.** Interconnected radio stations receiving program material from a central source.

**playlist.** A list of recordings to be played on the air.

**pot** (short for "potentiometer"). A volume control.

**PSA.** Public service announcement.

**remote.** Audio recorded or sent "on location"—that is, away from the radio studio. Often a radio station will send an air personality to "do a remote" from an advertiser's location to promote a special event.

**satellite radio.** Radio signals that are broadcast from a satellite in space to the listener, nearly always in digital form rather than conventional AM or FM.

**segue** (pronounced *SEG-way*). Without interruption; to play two recordings one after another with no silence or interrupting remarks.

**sound bite.** A short audio recording, most often used in news broadcasts or talk radio, where the sound bite is a few words from the subject of the news report.

**VU meter.** A meter used to measure the loudness or level of an audio signal, usually calibrated in volume units, although it might also measure sound levels in decibels (dB).



## Shortwave Listening

"This is the BBC, London, England . . . Radio Habana Cuba . . . Deutsche Welle . . . the Voice of the Andes, HCJB . . . Radio Taiwan International . . . the Voice of Russia . . . China Radio International, CRI, broadcasting from Beijing . . . News from Australia . . . NHK World Radio Japan . . ."

"Com Sta Miami, this is Coast Guard Rescue 148 at Andros Island, ETA Miami is 1300 hours. Have ambulance ready . . ."  
 ". . . American Airlines. Departing flight level 390 at 62 west. Temperature minus 54. Turbulence nil . . ."

Tune a shortwave receiver through the radio frequency bands and you will hear signals of all kinds. Some will be no more than a harsh buzz or a musical squeal. Others will be broadcasts from all over the world beamed at shortwave listeners.

Some of the signals you intercept will be conversations between airliners over the Atlantic Ocean and air traffic controllers in the United States, or mysterious code letters from military or "spy" stations in unknown places. The Coast Guard has many communications stations that can provide hours of listening, and the ship-to-shore telephone links are always busy.

### Code-Speak

Because no one outside the Navajo reservations could understand that language, the Marines enlisted Navajos to help them encode military messages during World War II. They developed a wordbook of 500 terms and an encoded phonetic alphabet, which the Navajo "code talkers" memorized. During the first two days of the U.S. attack on Iwo Jima, the code talkers translated more than 800 messages from English to Navajo, and back to English—without an error. The Navajo radio operators made a major contribution to the U.S. victory, and their code was never broken.





## Shortwave Broadcast Stations

You can listen to a drama on the BBC (British Broadcasting Corporation) or a concert of Russian music on Voice of Russia. At any time, there is some shortwave band open between where you live and some faraway place.

The easiest signals to pick up, especially on simple receivers, are from the many shortwave broadcast (SWB) stations. These stations are fun to listen to, and many shortwave listeners (SWLs) spend all of their listening time on SWB stations.

These stations broadcast in every conceivable language 24 hours a day. Some are religious in nature, some present political viewpoints, and others are primarily for entertainment. Each station tries to put the best face on its country, and this can lead to fascinating comparisons. Listen to the world news on the Voice of America, then follow with China Radio International (Beijing), and finish up with Radio Havana (Cuba) or Radio Tirana (Albania). It may be hard to believe that those broadcasts describe the same world.

The major SWB stations—such as the BBC, Voice of America (VOA), and China Radio International (CRI)—each transmit on many frequencies, often on more than one frequency on a single band. You can usually find one of those SWB stations on a band, and use that to judge the propagation. The WWV signals can also be helpful.

## Techniques of Listening

For the Radio merit badge, you are required to listen for four separate periods, at least one period in the daytime and at least one at night, so that you can compare the difference in the radio bands between the two. Although it isn't required, you might find it interesting to have one of the periods begin before local sunrise (or sunset) and end afterward. The line of light (at sunrise) or of darkness (at sunset) will approach from the east and proceed to the west. Listen carefully to the effect of the line as it passes you. What do you notice about stations you can hear, particularly stations to the east and west, as the line approaches and recedes? Check each band to see how the effect changes with frequency. Look on a map or globe and see if the stations you hear are in light or darkness.

You should learn the techniques of shortwave listening to get the most from the hobby. Pick a band and start at the lower end. Tune slowly up the band, stopping at each signal you hear. Tuning slowly is especially important if you are listening for utility (nonbroadcast) stations, since these may not be on the air all the time.

Once you hit the top of the band, go back to the beginning and try again. You will be surprised how much you can pick up on a second pass across a band. Then move on to another band, and come back later to try again as stations go on and off the air (often on the hour and half-hour) and propagation changes.

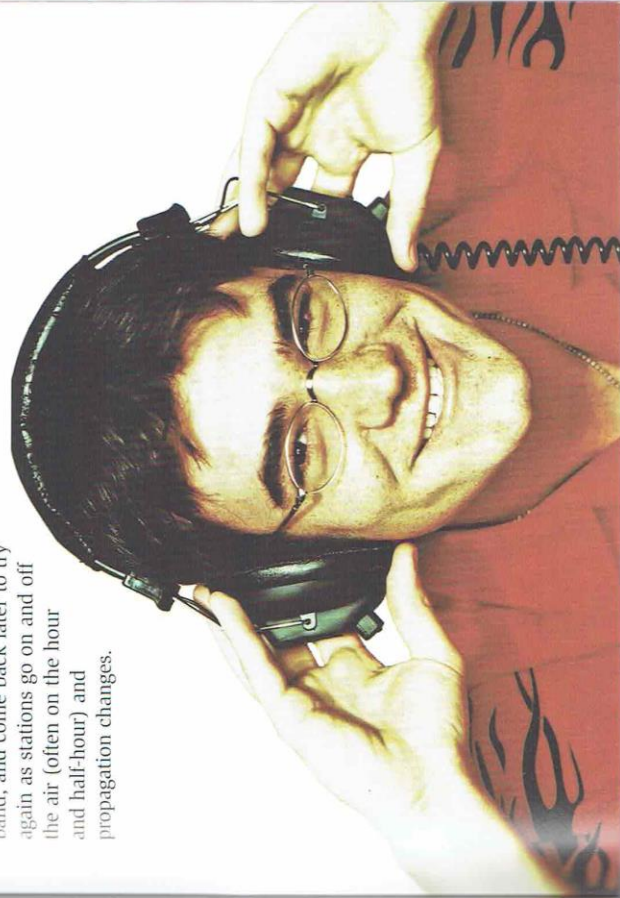



## Station IDs

Listen to each station long enough to identify (ID) it. If you can't make a positive ID after a reasonable period, make a note of the frequency and try again later.

How can you tell to whom you are listening? The language is not a good clue, even if you can identify it. If you are listening to a shortwave radio with your patrol some evening, you might hear Radio Taiwan in Spanish, Radio Argentina in French, the Voice of Turkey in Spanish, and the Voice of Russia in English, one right after the other—and not one would be speaking the native language of their own country. The VOA broadcasts in 43 languages including Uzbek and Azerbaijani, and is heard by about 134 million people worldwide. China Radio International has a similar global audience and broadcasts in about 53 languages including Esperanto, Swedish, and Tamil. So you can see, you will have many chances to hear a variety of languages on a few stations.

The best way to ID a station is to listen long enough to hear the station identification. Stations often identify only on the hour and half-hour. Even if you don't understand the language, you may be able to catch the ID. The word "radio" is the same in many languages, and the place name is usually given in the station's "home" language. Several SWL handbooks give you the ID in the languages most often used by the station, and also the theme song or "interval signal" used by the station.

The interval signal is often transmitted for several minutes before the station actually begins broadcasting, to hold the frequency and warm up the transmitters. Listen for a short phrase of music, repeated over and over: Deutsche Welle (Germany), for example, can often be heard playing a short tune on a celesta (a type of keyboard musical instrument). The BBC's interval is the Big Ben chimes. Radio Voice of Lebanon plays the "Bridge on the River Kwai March."

The frequency you are receiving can also give you a clue to the station. You can look up the frequency in a good SWL guide, and it might help. At least, it might give you some idea of what you should be listening for.

The screenshot shows the BBC website interface. At the top, there are navigation links for Home, News, Sport, Weather, Travel, Health, Arts, TV, Radio, News, and Search. Below the navigation is a large banner for 'COMBINE BACHELORS AND MASTERS' with a 'DISCOVER' button. The main content area is divided into several sections: 'Top Sport story' featuring a World Cup qualifier, 'News' with a headline about a government in Cyprus, 'Business' with a headline about a bank breakthrough, 'Sport' with a headline about a footballer, and 'Will we ever...' with a headline about a new station. There is also a 'Market' section with a table of stock prices.

Share	Change	%	
One Japan	1408.84	+ 14.0	0.9%
Nikkei	10282	+ 14.0	0.1%
FTSE 100	6282.75	+ 4.1	0.0%
Dax	9117.25	+ 1.9	0.0%
Cas4E	2179.28	+ 4.8	0.2%

Don't expect to identify a signal based only on frequency. Many frequencies are shared by more than one station. Some stations change their frequencies regularly. Sometimes a new station will spring up on top of an old station, prompting the older station to move to avoid the interference.

As you listen to the bands, log the stations you hear and identify them (no fair entering an ID unless you're sure). You should log the frequency, the date, and the station ID and/or location, the emission mode (AM/SSB/CW), and the signal quality. Be sure to log time and date in 24-hour Greenwich Mean Time (GMT), or "Zulu" time (now officially called Coordinated Universal Time or UTC outside of Great Britain) rather than in your own local time, since that is the standard used by all SWB stations.



The signal quality is usually given in SINPO code (instead of the RST report that hams use). This code assigns a five-digit number to the signal from 11111 to 55555. The digits represent signal strength, interference, noise, propagation (fading), and overall merit, with 5 being excellent and 1 being poor.

## Reception Reports

Log enough details about the program being transmitted so that the station can confirm that you have, indeed, heard its signal. This is called a *reception report*. You can send reception reports to the broadcast stations you hear, and most of them will send you a QSL card in return. An SWL guide can tell you how to send reports to given stations. Sometimes a station will invite reports on the air and will give an address to write to, and many stations have websites.

The screenshot shows the website 'THE VOICE OF RUSSIA'. The navigation menu includes: Home, Radio, International, Music, Russian, English, Arabic, Chinese, and Other. The main content area features several news articles with headlines such as: 'Lebanon's Prime Minister Naji Mikati resigns', 'Russia and China sign cooperation agreement in energy, exploration, and science', 'Sulaiman Tamer al-Bitar and his wife', 'Banker resigns C. Clinton's husband', 'Russia, China to establish ties', 'BOLCS Durban summit: Russia's stance', 'Will the Atlantic see the West?', 'After a decade without US', 'Who is to become head of the US?', 'Cyrus considers alternative course', and 'What is to stop the spread of...'. Each article includes a small image and a brief summary of the news item.

Before spending time and money sending reception reports and requesting QSL cards, study the guidelines issued by listener clubs and some radio stations (such as Voice of Russia). You may send reports to international broadcasters in the language of the broadcast you heard, or in the station's native language. Return postage is often appreciated but not always necessary to receive a QSL card. Offer some comments on the program to prove that you really did listen to it. Use the SINPO code to indicate reception quality.

## Bands for Listening

Here are some of the best bands for shortwave listening:

### Shortwave broadcasting

5.95 to 6.2 MHz  
7.1 to 7.3 (also a ham radio band in the United States)

9.5 to 9.775  
11.7 to 11.975  
15.1 to 15.45

### Aeronautical stations

4.65 to 4.75 kHz (all upper sideband, or USB)  
5.4 to 5.73  
6.525 to 6.765  
8.815 to 9.04  
11.175 to 11.4

### Ship-to-shore

4.068 to 4.438 MHz (all USB)  
6.2 to 6.525  
8.4 to 8.7  
12.33 to 13.2

### Military, etc.

2.182 MHz (USB)—International distress frequency  
5.696—Search and rescue  
6.506.4—Coast Guard  
8.9 to 9.0—Military aeronautical



## Careers in Radio

As part of earning the Radio merit badge, you will visit a radio installation. While there, be sure to ask about careers in radio. Talk to any operators, technicians, or engineers you meet about their positions, how they trained for the work, what they like about it, and the skills they need. Ask what education is required to pursue a radio career.

Find out about ways to get experience. If a career in broadcast radio is your goal, maybe you can land an internship at a local radio station. Or, as an amateur radio operator, you might want a part-time position in a store that sells and services ham radio gear. Your interest in ham radio, shortwave radio, and electronics could lead eventually to a career as an electronics technician, for instance, working on radio equipment. You might start as a hobbyist, then move into a career in electronic consumer products, electronics technology, or telecommunications.

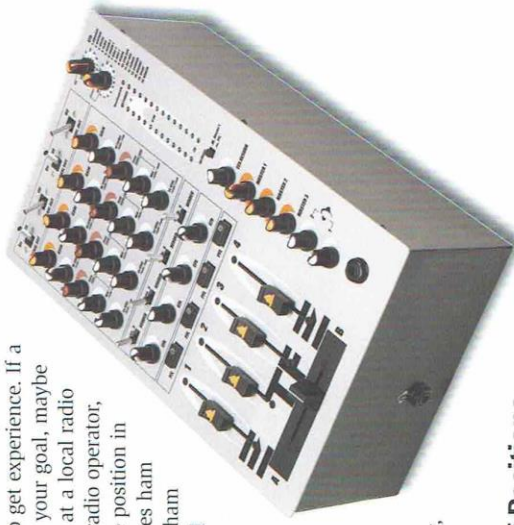

### Radio Station Staff Positions

Besides the air personality who plays songs and does the announcing, many other people work at broadcast radio stations. Other on-the-air personalities include news reporters, sportscasters, weather reporters, commuter traffic reporters, talk-show hosts, and commercial announcers.





Behind the mike are still other people, except in the smallest stations.

**The engineer** maintains the station equipment and transmitter and is responsible for making sure the station complies with FCC regulations. It may be the engineer's responsibility to take transmitter readings from time to time to keep track of the power and condition of the station's transmitter. This function can be computerized or done by the air personalities in some stations.

**The program director** is responsible for the "sound" of the station and chooses the right music for the format, establishes lists of songs to be played, and supervises the on-air personalities to be sure the station follows its format. The program director is responsible to the station management for the success of the station.



**The music director** communicates with record label companies about new music and gathers music sales reports from retail stores. This individual listens to all new music being sent to the station for air play, tracks and reports what is being played on the station, and makes suggestions about which new songs to add to the playlist or rotation.

**The production director** produces advertising and station promotional spots and maintains the production studio.

**The copywriter** writes the commercial copy (the text or words) for spots and may double as a newswriter. **Newswriters** take news items from a news service and rewrite them for the announcer to read.

**The traffic director** schedules all of the commercials. This staff member also ensures that spots are produced and aired according to the customers' specifications.

**The sales staff** sells radio ads to advertisers and helps plan advertising campaigns for the station. **The promotions department** promotes the station through advertising, contests, and special events.



### Training for a Broadcasting Career

Colleges and technical schools around the country offer programs in radio and television announcing, writing, and production.

Ask your counselor to help you find a college that suits your interests. Many colleges and universities have student-run radio stations that offer opportunities to gain experience, which can be valuable in seeking a position in this competitive business. Many professional stations have internships for students to earn course credits while working and learning at a radio station.

Most announcers start out in small cities or minor stations, hoping to work their way up to the major markets like New York or Los Angeles or to a network. It isn't easy to get ahead in radio, but if you have talent and are willing to work hard, it can be a rewarding career.



# Radio Resources

## Scouting Literature

*Computers, Electricity, Electronics, Emergency Preparedness, Energy, Robotics, and Search and Rescue* merit badge pamphlets

Visit the Boy Scouts of America's official retail website (with your parent's permission) at <http://www.scoutstuff.org> for a complete listing of all merit badge pamphlets and other helpful Scouting materials and supplies.

## Books and Other Resources

Many of the books, CDs, and other resources listed here are available from the American Radio Relay League. See page 96 for contact information.

## AMATEUR RADIO

Alvareztorres, Al, AA1DO, and Ed Hare, W1RFL, compilers. *Ham Radio FAQ*. American Radio Relay League Inc., 2001. Answers to frequently asked questions about antennas, station setup and operation, and other issues.

*Amateur Radio Today*. ARRL Inc., 2003. Six-minute video narrated by former CBS news anchor Walter Cronkite, KB2GSD; showcases the public service contributions made by hams.

*The ARRL Emergency Communication Handbook*. ARRL Inc., 2005. For hams who want to help with communications during emergencies or disasters.

*The ARRL Ham Radio License Manual*. ARRL Inc., 2010. A beginners' guide to amateur radio and preparation for the ham radio license test.

Barasch, Lynne. *Radio Rescue*. Farrar, Straus and Giroux, 2000. The story of a young amateur radio operator whose skills led to the rescue of a family stranded by a hurricane.

*Basic Technology for the Amateur Radio Enthusiast*. Alpha Delta Communications Inc., 2000. Basic electronics; a brief history of radio, and a virtual tour through a receiver. Includes book with 23-minute VHS videotape.





*Getting Started With Ham Radio*. ARRL Inc., 2006. A guide to your first amateur radio station: choosing and installing equipment, making your first voice contacts, setting up for digital operating, operating on various bands and modes, etc.

Hallas, Joel, W1ZR. *Basic Radio: Understanding the Key Building Blocks*. ARRL Inc., 2005. An introduction to radio with simple, build-it-yourself projects.

Silver, H. Ward. *Ham Radio for Dummies*, 2nd ed. John Wiley & Sons, 2013.

#### *Your Introduction to Morse Code*.

ARRL Inc., 2010. Simple guide for electronics beginners with explanations of basic electronics principles and how components work.

*Your Introduction to Morse Code*. ARRL Inc., 2006. Morse code instruction and practice for those who want to learn the “universal language” of ham radio. Includes two audio CDs and instruction booklet.

#### BROADCAST RADIO AND SHORTWAVE LISTENING

Bureau of Labor Statistics, U.S. Department of Labor. *Occupation Outlook Handbook, 2012–13 ed.* See “Media and Communication,” online at <http://www.bls.gov/ooh/home.htm>.

Field, Shelly. *Career Opportunities in Radio*. Checkmark Books, 2004. Profiles of more than 70 career opportunities in the radio business.

*World Radio TV Handbook: The Directory of Global Broadcasting*. WRTH Publications. Published annually, a guide to the world of radio including domestic radio services and broadcasters transmitting internationally.

#### Acknowledgments

The Boy Scouts of America is grateful to the following for their work on this revision of the *Radio* merit badge pamphlet: In particular, Mike Brown, WB2JWD, Harford, New York, who coordinated the overall revision; Bill Burns, WA6QYR, Ridgecrest, California; Allan Koch, KA8JJN, Clinton Township, Michigan; and Larry Wolfgang WR1B, Newington, Connecticut, for contributing to the “Amateur Radio” section and related portions of the pamphlet. Thanks to Donald L. Perkins, N21VW, operations manager and engineer, Central New York Radio Group, for his help in revising the “Broadcast Radio” section of the pamphlet.

The BSA thanks the staff and volunteers of the American Radio Relay League for many contributions over the years, and for those materials reprinted with the permission of the ARRL from its publications and website.

Acknowledgements are due to the following for their contributions to previous versions of the book, which were incorporated into this revision: Mike Brown, WB2JWD, and Laurence A. Eichel, K2NA, for the original 1989 version; to Rosalie White, K1STO; Mary Garcia, N71AL; Robin M. Mickett, N1WAL; Karen A. Leyton; Jean Wolfgang, WB3IOS; and Labron Morgan of Westwood One, Dallas, Texas, for their assistance with the 1996 revision.

The Boy Scouts of America is grateful to the men and women serving on the Merit Badge Maintenance Task Force for the improvements made in updating this pamphlet.

#### Photo and Illustration Credits

American Radio Relay League, courtesy—page 67

Mike Brown, WB2JWD, courtesy—pages 28 and 35 (*background photo*)

NASA, courtesy—pages 8 and 58 (*bottom badge*); pages 5–6 (*both*), 11 (*bottom*), 12, 13 (*bottom*), 18, 22 (*bottom*), 26 (*top*), 29, 66, 68–71 (*all*), 73, 83, and 89–92 (*all*)

©Photos.com—cover (*all except merit badge*); pages 5–6 (*both*), 11 (*bottom*), 12, 13 (*bottom*), 18, 22 (*bottom*), 26 (*top*), 29, 66, 68–71 (*all*), 73, 83, and 89–92 (*all*)

Shutterstock.com—pages 8 (*background*), 734435 ©Linda Webb), 10 (54864907 ©Monkey Business Images), and 90 (68510689 ©ra2studio), 2013 Used under license from Shutterstock.com

Shutterstock.com—pages 88 (antb/Shutterstock, courtesy) and 91 (wavebreakmedia/Shutterstock, courtesy)

Society for the Preservation of Amateur Radio, [www.spar-hams.org](http://www.spar-hams.org), courtesy—page 52 (*bottom*)

Wikipedia.org, courtesy—pages 3, 9, 11 (*top left*, *top right*), 20, 22 (*top*), 58 (*top right*), 61, 62 (*bottom*), and 80 (*inset*)

All other photos and illustrations not mentioned above are the property of or are protected by the Boy Scouts of America.

Daniel Giles—pages 24, 53–54 (*both*), and 63

F. Harvell—page 52 (*top*)

John McDearmon—pages 16, 19, 26 (*bottom*), 31–32 (*all*), 36–39 (*all*), 41, and 60

Brian Payne—page 25

Randy Piland—pages 13 (*top*), 50, 65, 72, 74, 80 (*main*), and 88

Emery Shepard—page 57 (*both*)



## To the Radio Merit Badge Counselor

Thanks for your interest in introducing Scouts in your area to the wonders of radio. The ARRL wants to help you make each Scout's experience in earning the Radio merit badge exciting, challenging, and fun. If you would like ideas on JOTA, information about teaching for the amateur radio license, or promotional brochures on Scouting and ham radio, visit the ARRL website at <http://www.arrl.org>. Or, contact the ARRL for more information:

Scouting  
 American Radio Relay League (ARRL)  
 225 Main St.  
 Newington, CT 06111  
 Telephone: 860-594-0200



The American Radio Relay League has signed a memorandum of understanding with the Boy Scouts of America. This MOU emphasizes a cooperative and ongoing relationship to support mutually beneficial programs that foster and promote education, technical awareness, and achievement in amateur radio, emergency preparedness and communications, and other joint efforts and undertakings.

## MERIT BADGE LIBRARY

Though intended as an aid to Boy Scouts, Varsity Scouts, and qualified Venturers and Sea Scouts in meeting merit badge requirements, these pamphlets are of general interest and are made available by many schools and public libraries. The latest revision date of each pamphlet might not correspond with the copyright date shown below, because this list is corrected only once a year, in January. Any number of merit badge pamphlets may be revised throughout the year; others are simply reprinted until a revision becomes necessary.

If a Scout has already started working on a merit badge when a new edition for that pamphlet is introduced, *he may continue to use the same merit badge pamphlet to earn the badge and fulfill the requirements therein.* In other words, the Scout need not start over again with the new pamphlet and possibly revised requirements.

Merit Badge Pamphlet	Year	Merit Badge Pamphlet	Year	Merit Badge Pamphlet	Year
American Business	2013	Entrepreneurship	2013	Pioneering	2013
American Cultures	2013	Environmental Science	2006	Plant Science	2013
American Heritage	2013	Family Life	2008	Plumbing	2004
American Labor	2014	Farm Mechanics	2008	Pottery	2008
Animal Science	2014	Fingerprinting	2003	Programming	2013
Archaeology	2013	Fire Safety	2004	Public Health	2005
Archery	2013	First Aid	2007	Public Speaking	2013
Architecture and Landscape Architecture	2010	Fish and Wildlife Management	2004	Pulp and Paper	2006
Art	2013	Fishing	2013	Radio	2013
Astronomy	2013	Fly-Fishing	2009	Railroading	2003
Athletics	2006	Forestry	2005	Reading	2003
Automotive Maintenance	2012	Game Design	2013	Reptile and Amphibian Study	2005
Aviation	2006	Gardening	2013	Rifle Shooting	2012
Backpacking	2007	Genealogy	2005	Robotics	2011
Basketry	2003	Geocaching	2010	Rowing	2014
Bird Study	2005	Geology	2005	Safety	2013
Bugling (see Music)	2005	Golf	2002	Salesmanship	2013
Camping	2005	Graphic Arts	2002	Scholarship	2004
Canoeing	2004	Hiking	2007	Scouting Heritage	2014
Chemistry	2004	Home Repairs	2009	Scuba Diving	2009
Chess	2011	Horsemanship	2013	Sculpture	2007
Cinematography (see Movie-making)	2008	Indian Lore	2008	Search and Rescue	2012
Citizenship in the Community	2005	Insect Study	2008	Shotgun Shooting	2013
Citizenship in the Nation	2005	Journalism	2010	Skating	2005
Citizenship in the World	2005	Kayaking	2006	Snow Sports	2004
Coin Collecting	2011	Landscaping Architecture (see Architecture)	2012	Soil and Water Conservation	2014
Collections	2008	Law	2003	Space Exploration	2004
Communication	2009	Leatherwork	2013	Sports	2006
Composite Materials	2006	Lifesaving	2008	Stamp Collecting	2013
Computers (see Digital Technology)	2009	Mammal Study	2003	Surveying	2004
Cooking	2013	Medicine	2009	Sustainability	2013
Crime Prevention	2005	Metalwork	2007	Swimming	2008
Cycling	2005	Model Design and Building	2010	Textile	2014
Dentistry	2013	Motorboating	2008	Theater	2005
Digital Technology	2013	Motorboating	2013	Traffic Safety	2006
Disabilities Awareness	2005	Music and Bugling	2013	Truck Transportation	2005
Dog Care	2012	Nature	2014	Veterinary Medicine	2005
Drafting	2008	Nuclear Science	2010	Water Sports	2007
Electricity	2013	Oceanography	2009	Weather	2013
Electronics	2004	Orienteering	2003	Welding	2012
Emergency Preparedness	2012	Painting	2008	Whitewater	2005
Energy	2005	Personal Fitness	2013	Wilderness Survival	2007
Engineering	2008	Personal Management	2003	Wood Carving	2006
		Pets	2003	Woodwork	2011
		Photography	2013		

## BOY SCOUTS OF AMERICA • SUPPLY GROUP

### NATIONAL DISTRIBUTION CENTER

2109 Westinghouse Boulevard  
 P.O. Box 7143  
 Charlotte, NC 28241-7143

[www.scoutstuff.org](http://www.scoutstuff.org)

### DIRECT MAIL CENTER

P.O. Box 909  
 Pineville, NC 28134-0909  
 For fast credit card orders —  
 VISA, MasterCard, American Express —  
 call BSA operators toll-free  
 1-800-323-0732